

XRAY NT1

1/10 LUXURY NITRO TOURING CAR

PURE RACING DESIGN

LUXURY PREMIUM QUALITY

HIGHEST PERFORMANCE

LOWEST COST

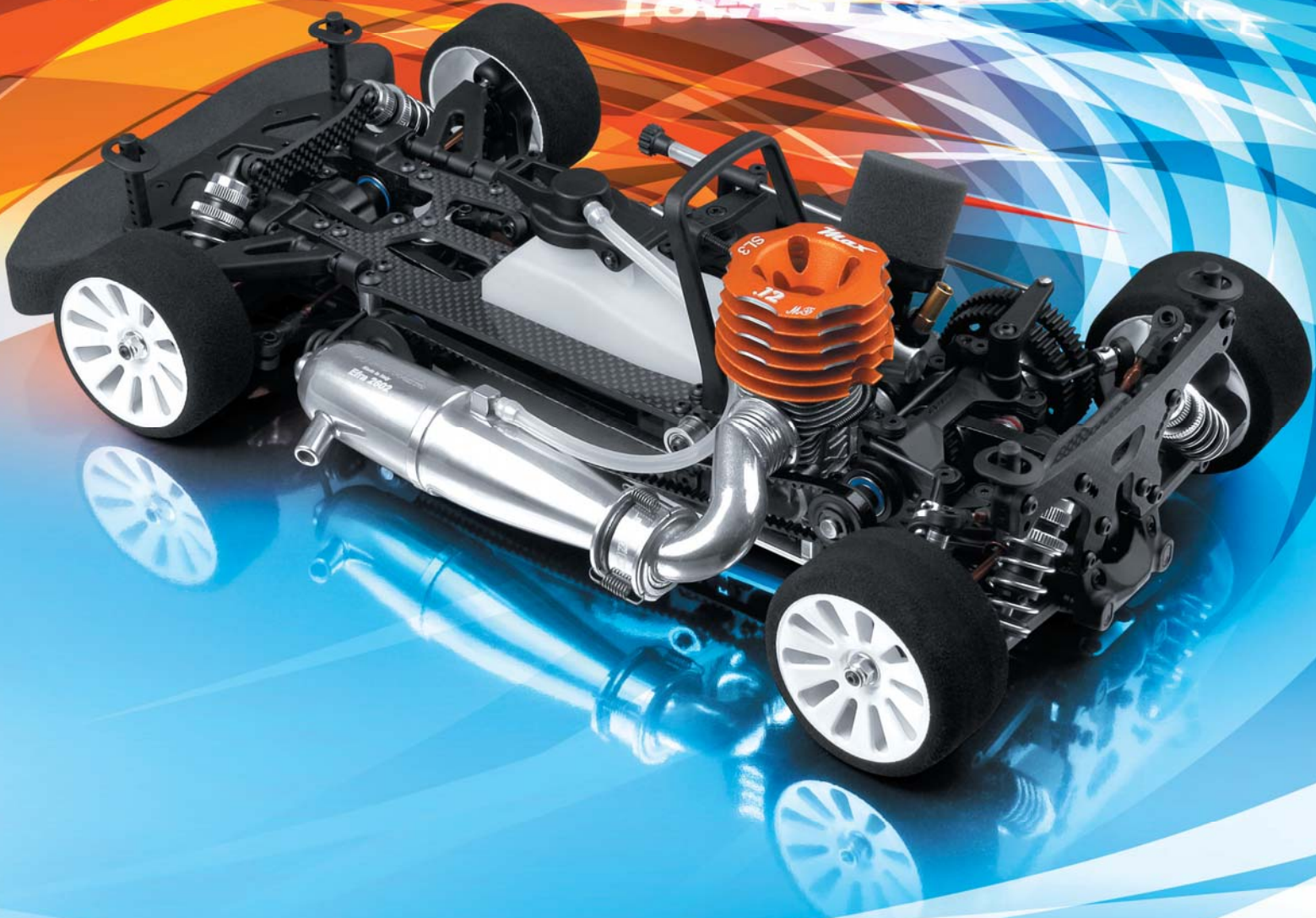

SET-UP BOOK

XRAY

| | |
|--------------------------------------|-----------|
| Setting Up the XRAY NT1 | 3 |
| Set-up Order | 4 |
| Terminology | 4 |
| Weight Transfer | 5 |
| Weight Balance | 5 |
| Center-of-gravity | 5 |
| Downstops | 5 |
| Effects of Downstop Adjustment | 6 |
| Measuring Downstops | 6 |
| Adjusting Downstops | 7 |
| Shock Absorbers | 8 |
| Shock Spring Rate | 8 |
| Effects of Spring Rate Selection | 8 |
| Shock Spring Preload | 9 |
| Shock Position | 9 |
| Effects of Shock Position Adjustment | 9 |
| Adjusting Shock Position | 9 |
| Shock Damping | 10 |
| Effects of Shock Damping Adjustment | 10 |
| Adjusting Shock Damping | 11 |
| Track-width | 11 |
| Effects of Track-width Adjustment | 12 |
| Measuring Track-width | 12 |
| Adjusting Track-width | 12 |
| Ride Height | 13 |
| Effects of Ride Height Adjustment | 13 |
| Ride Height and Tires | 13 |
| Ride Height and Suspension Settings | 13 |
| Measuring Ride Height | 13 |
| Adjusting Ride Height | 14 |
| Camber | 14 |
| Measuring Camber | 15 |
| Adjusting Camber | 15 |
| Caster | 16 |
| Effects of Caster Adjustment | 16 |
| Adjusting Caster | 17 |
| Toe | 17 |
| Effects of Toe Adjustment | 17 |
| Measuring Toe | 17 |
| Adjusting Toe | 18 |
| Anti-roll Bars | 19 |
| Effects of Anti-roll Bar Adjustment | 19 |
| Adjusting Anti-roll Bars | 19 |

| | |
|--|-----------|
| Tweak | 20 |
| Combating Tweak | 20 |
| Measuring & Correcting Tweak | 21 |
| XCA Clutch | 23 |
| Building and Maintaining the XCA Clutch | 23 |
| Flywheel Shimming | 24 |
| Adjusting Flywheel Distance | 24 |
| Clutch Spring Preload | 24 |
| Effects of Clutch Spring Preload | 24 |
| Adjusting Clutch Spring Preload | 24 |
| Clutch Gap | 25 |
| Effects of Clutch Gap Adjustment | 25 |
| Adjusting Clutch Gap | 25 |
| Clutchbell Endplay | 25 |
| Effects of Excessive Clutchbell Endplay | 25 |
| Adjusting Clutchbell Endplay | 26 |
| Clutch Shoes | 26 |
| 2-speed Transmission | 26 |
| Shift Point | 26 |
| Adjusting Shift Point | 27 |
| Transmission Shoe Gap | 27 |
| Adjusting Transmission Shoe Gap | 27 |
| Multi-Flex Technology™ | 28 |
| Effects of MFT™ Adjustment | 28 |
| Adjusting Chassis Stiffness with MFT™ 1-piece Engine Mount | 28 |
| Roll Center | 29 |
| Roll Center Basics | 29 |
| Roll Center in Action | 29 |
| Effects of Roll Center Adjustment | 29 |
| Adjusting Roll Center | 30 |
| Camber Rise | 32 |
| Adjusting Camber Rise | 32 |
| Steering Ackermann | 33 |
| Adjusting Ackermann | 33 |
| Front and Rear Axles | 34 |
| Gear Differentials | 34 |
| Effects of Gear Differential Adjustment | 34 |
| Adjusting the Gear Differentials | 34 |
| Solid Front Axle | 35 |
| XRAY Multi-diff™ | 35 |
| Gearing | 36 |
| Drivetrain Ratio (DTR) — Internal Ratio | 36 |
| Primary Drive Ratio (PDR) | 36 |
| Final Drive Ratio (FDR) | 37 |
| Overdrive Ratio (ODR) | 37 |
| Rollout | 37 |
| Overdrive Ratio, Rollout, and Tire Size | 37 |
| Shock Building Tips | 38 |
| Periodic Shock Maintenance | 38 |
| Fill and Bleeding Process | 38 |
| Foam Tire Tips | 39 |
| Bearing Maintenance | 39 |



Martin Hudy, Junior Designer at XRAY R&D, guides you through the set-up theory of the XRAY NT1 and discloses all the tips & tricks to make your NT1 a winning car.

All texts and images contained within this set-up book are copyright by XRAY. All rights reserved. ©2007 XRAY

SETTING UP THE XRAY NT1

Setting up a nitro-powered racecar with fully-independent suspension, clutch, and multi-speed transmission — like your XRAY NT1 — is necessary to make the car perform well. We have developed the NT1 Setup Book to help you set up your NT1 properly and easily. Follow the procedures carefully, and always make sure that you make equal adjustments on left and right sides of the car.

In addition to describing how to measure and adjust your NT1, the NT1 Setup Book contains detailed information about the effects of setting adjustments so that you will have a better understanding of them.

Throughout the NT1 Setup Book, we refer to handling effects of the car in the corner, and distinguish three corner sections and three throttle/brake positions as follows:

| Corner sections: | Throttle/brake positions: |
|------------------|---------------------------|
| • corner entry | • braking |
| • mid-corner | • off-throttle |
| • corner exit | • on-throttle |

Car setup is a complex matter, as all adjustments interact. Fine-tuning your car's setup will make it faster and often easier to drive near its performance limit. This means that all the effort you put into preparing your NT1 and optimizing its setup will help pay off in better performance, results, and satisfaction.

Chassis stiffness (especially torsional) is an important factor when setting up your car. A stiff chassis helps to eliminate chassis flexing and twisting, which would otherwise introduce another factor that is not easy to measure or adjust. However, chassis stiffness is also a setup tool. By altering chassis stiffness (for example, using a different engine mount) you can make a "softer" or "stiffer" car that may be more or less suited to track conditions or driving style. The NT1 features the exclusive XRAY Multi-Flex Technology™ engine mounting system which enables you to adjust the chassis stiffness.

If you choose to adjust the setup of your NT1, make small adjustments one at a time, and see if you find any improvement in performance and/or handling with each adjustment. We advise you to keep track of your setup changes, and record which setups work best at different racetracks under various conditions. You can upload your NT1 setup settings to the XRAY Online Virtual Setup Sheet Database at www.teamxray.com and access your personal settings from anywhere in the world at any time. You can also benefit from all the setup sheet knowledge and download setup sheets from XRAY factory team drivers.

Remember that for your NT1 to work and respond to setup changes properly, it must first be in good mechanical shape. Check the well functioning of critical areas such as the free movement of the suspension, smoothness of shock absorbers, and adjustment and wear of clutch and transmission parts after each run (and especially after a collision).

After rebuilding the chassis, or in case you become lost with your setup, always return to the last setup you have recorded, or use one of the NT1 setups posted by others.

When setting up your NT1, we strongly recommend using the HUDY All-In-One Set-Up Solution #108255, a high-precision professional set-up system that includes all necessary setup tools and equipment.

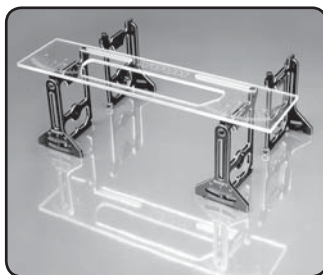

109305 UNIVERSAL EXCLUSIVE ALU. SET-UP SYSTEM FOR TOURING CARS

- CNC-machined alu. and acrylic components
- fully ball-bearing equipped
- precision engraving
- directly measures camber, camber rise, caster, toe, steering throw symmetry
- easy one-screw assembly/disassembly



PROFESSIONAL TWEAK STATION FOR 1/10 TOURING CARS

- best-in-class integrated solution for quick and easy track & tweak adjustment
- innovative, easy-to-use, high-tech design
- fully ball-bearing equipped for smoothness and high precision
- ultra-sensitive balance platform gives highly-accurate readings, allowing you to easily and quickly read and interpret tweak
- rugged CNC-machined aluminum construction, fully assembled



107702 DROOP GAUGE SUPPORT BLOCKS

- CNC-machined high-grade aluminum
- precision engraving
- supports chassis when checking downstops
- used with 107712 Droop Gauge

SETTING UP THE XRAY NT1



107712 DROOP GAUGE

- CNC-machined high-grade aluminum
- precision engraving
- measures downstops when used with 107702 Droop Gauge Support Blocks



107715 RIDE HEIGHT GAUGE

- CNC-machined high-grade aluminum
- precision engraving
- measures ride height

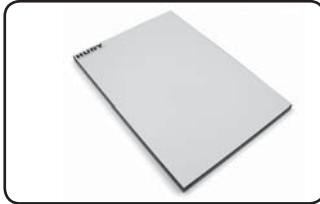

108201 SET-UP BOARD

- suitable for 1/10 R/C touring cars
- exceptionally flat, warp-resistant surface
- very small, compact size
- provides perfectly flat reference surface for chassis set-up



108211 SET-UP BOARD DECAL

- self-adhesive set-up decal for 108201 Set-Up Board
- accurate, clear markings with 1mm grid for adjustment of 1/10 touring cars
- tough, smooth, liquid-resistant plastic surface

SET-UP ORDER

The table below gives you a breakdown of the following:

- recommended order of setup
- car components to be attached/detached for a particular setting
- setup components to be used for a particular setting

We recommend setting up your NT1 chassis in the order indicated in the table below. The order of the chassis settings has been determined as the most logical to set up your NT1 chassis properly and easily. Also, certain chassis settings must be made before others, as changing one setting will impact another setting.

| SETTING | Page | CAR COMPONENTS | | | SETUP COMPONENTS | | | | |
|----------------|------|----------------|----------------|--------|------------------|-----------------|-------------------|-----------|--------------------|
| | | Shocks | Anti-roll Bars | Wheels | Setup Stands | Droop Gauge Set | Ride Height Gauge | Toe Gauge | Flat Board & Decal |
| 1. Downstops | 5 | X | X | X | | ✓ | | | ✓ |
| 2. Track-width | 11 | ✓ | | ✓ | | | | | ✓ |
| 3. Ride Height | 13 | ✓ | ✓ | ✓ | | | ✓ | | ✓ |
| 4. Camber | 14 | ✓ | X | X | ✓ | | | | ✓ |
| 5. Caster | 16 | | | | | | | | |
| 6. Toe | 17 | ✓ | | X | ✓ | | | ✓ | ✓ |
| 7. Tweak | 20 | ✓ | X / ✓ | ✓ | | | | | ✓ |

✓ : Attach / Use

X : Detach / Do Not Use

TERMINOLOGY

The terms "understeer" and "oversteer" appear throughout this manual. These terms describe a particular handling characteristic of the car.

Understeer

Also known as "push."

A car understeers when the front wheels do not grip enough and the rear tires grip too much. This results in a front end that slides too much rather than turning. A car that understeers is easier to drive, but it is slower than a car that oversteers slightly.

Oversteer

Also known as "loose."

A car oversteers when the front wheels grip too much and the rear tires do not grip enough. This results in a rear end that slides too much. Excessive oversteer causes the rear tires to "break loose" allowing the car to spin out.

WEIGHT TRANSFER

Weight transfer is the key to car handling. Consider that a car has a certain amount of “weight” on various parts of the car and this weight is distributed by a certain amount into each wheel.

- When the car corners, weight is transferred to the outside tires
- When the car accelerates, weight is transferred to the rear
- When the car brakes, weight is transferred to the front.

By transferring weight to one side of the car (left or right) or one end of the car (front or rear), the tires on that side (or at that end) will be forced onto the racing surface more, resulting in more grip or traction at that side/end. The amount of weight transfer is affected by the car’s center-of-gravity (CG), distribution of the weight by the car’s setup, and the way you drive.

Before you start adjusting your car’s setup, you should ensure the following:

- Car is in good mechanical shape with no broken, binding, or loose parts
- Car has proper weight balance front/rear and left/right

WEIGHT BALANCE

You should always try to adjust the weight on your car so it is equal left-to-right — this will help to ensure proper, consistent handling. You can use balancing tools to check the weight distribution of your car, and ensure that your ready-to-race car does not list to one side.

We recommend using the #107880 HUDY Chassis Balancing Tool.

CENTER-OF-GRAVITY

The center-of-gravity (CG) of the car is the point on the car (in 3 dimensional space) around which the car moves, and the point at which all force is applied while the car is in motion.

- When the car goes around a corner, centrifugal force pushes the car to the outside of the turn, and this force pushes on the car’s CG causing the car to tilt or roll to the outside. This transfers weight to the outside wheels of the car.
- When the car accelerates, the force pushes backward on the car’s CG, causing the car to tilt backward. This transfers weight to the rear wheels.
- When the car brakes, the force pushes forward on the car’s CG, causing the car to tilt forward. This transfers weight to the front wheels.

Center-of-gravity is affected by the physical weight of the car, and the placement of all components on the car. If the car is not equally balanced front/rear and left/right, the car’s CG will not be centered. This will cause the car to handle differently when it turns one direction as opposed to the other direction.

It is always best to make the car’s CG as low as possible to minimize the negative effects of weight transfer. Do this by placing all components as low as possible on the car’s chassis, and reduce weight high on the chassis.

WEIGHT TRANSFER AND CAR SET-UP

Car setup is always a matter of compromise, and every aspect of car setup affects how weight transfers on the car. There is no one “magical” setup change that will solve all of your car’s handling problems. Car setup is a complex interaction of the various components that make up the car, and all of these aspects of setup will affect one another.

DOWNSTOPS

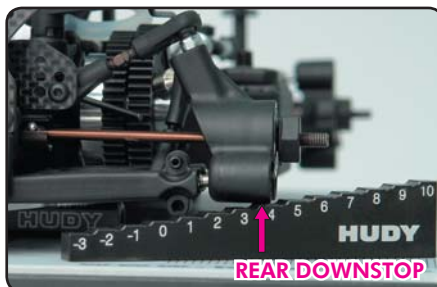
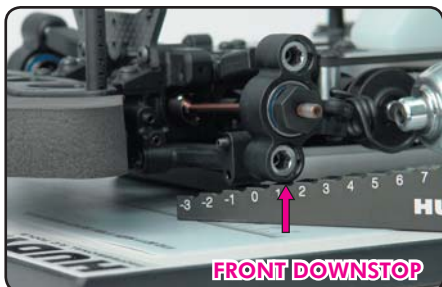

Downstops limit how far the suspension arms travel downward, which determines how far upward the chassis rises. This affects the car’s handling (due to effects on camber and roll-center) and the ability of the tires to “follow” the track. The effects may change with the type of track and/or amount of grip available.

More suspension travel (lower downstop value) makes the car more responsive but less stable; it is also typically better on a bumpy tracks or tracks with slow corners. Less suspension travel (higher downstop value) makes the car more stable and is typically better on smoother tracks.

It is very important to have the same downstop settings on the left and right sides of the car.

EFFECTS OF DOWNSTOP ADJUSTMENT

| Front Downstops | |
|------------------------------------|---|
| Higher front downstop value | <ul style="list-style-type: none"> • Decreases front chassis upward travel on-throttle. • Increases high-speed steering. • Increases "initial" on-throttle understeer. • Better on smooth tracks. |
| Lower front downstop value | <ul style="list-style-type: none"> • Increases upward chassis travel on-throttle. • Decreases high-speed steering. • Decreases "initial" on-throttle understeer. • Better on bumpy tracks. |
| Rear Downstops | |
| Higher rear downstop value | <ul style="list-style-type: none"> • Decreases rear chassis upward travel off-throttle or under braking. • Increases stability under braking. • Better on smooth tracks. |
| Lower rear downstop value | <ul style="list-style-type: none"> • Increases rear chassis upward travel off-throttle or under braking. • Increases steering in slow corners. • Better on bumpy tracks. |

MEASURING DOWNSTOPS

| INITIAL STEPS | SET-UP COMPONENTS: |
|---|---|
| Prepare the car as follows: <ul style="list-style-type: none"> • Shocks: Detach the shocks. • Anti-roll bars: Detach the anti-roll bars. • Wheels: Remove the wheels. | Use the following set-up components: <ul style="list-style-type: none"> • Droop Gauge Support Blocks • Droop Gauge |



1. Place the droop gauge support blocks on the setup board, and then place the chassis on the support blocks. Make sure the chassis is solidly mounted on the support blocks so it does not move.



2. Lift and drop the suspension arms so that they settle in their lowest positions.

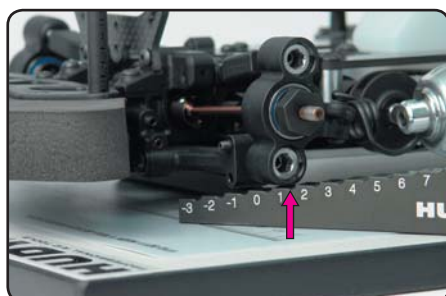

3. Using the droop gauge, measure the downstop value from the bottom of the front steering blocks / rear uprights..

FRONT DOWNSTOPS

Measure at the bottom of the steering block. Do NOT measure under the arm.

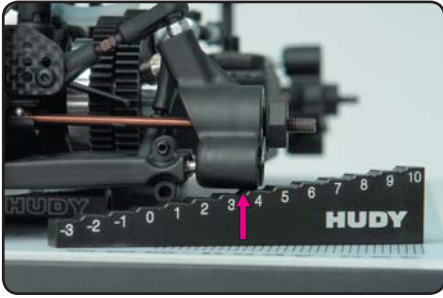

REAR DOWNSTOPS

Measure at the bottom of the rear uprights. Do NOT measure under the arm.

Droop Gauge Values

- Positive numbers on the gauge indicate the distance (in mm) ABOVE the top level of the elevating blocks (or, above the bottom of the chassis).
- Negative numbers on the gauge indicate the distance (in mm) BELOW the top level of the elevating blocks (or, below the bottom of the chassis).

ADJUSTING DOWNSTOPS

Adjust the front and rear downstops using the downstop setscrews in the front bulkheads and rear lower arms, respectively.

IMPORTANT: Make sure you adjust downstops so they are equal on both left and right sides.



ADJUSTING FRONT DOWNSTOPS

Set the front downstops so the bottoms of the steering blocks are at a specific value on the gauge.

Adjust front downstops by turning the downstop setscrews into or out of the front bulkheads.

- **INCREASE front downstop:**
Turn IN (CW) the front downstop screw so the front lower arm rises.
- **DECREASE front downstop:**
Turn OUT (CCW) the front downstop screw so the front lower arm drops.

IMPORTANT: Measure the front downstop under the steering block.

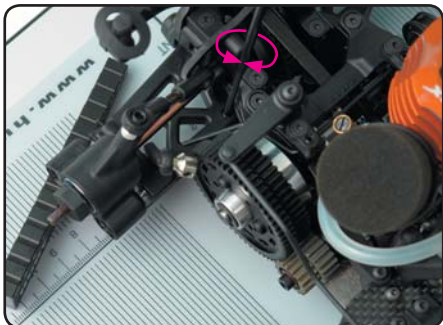

ADJUSTING REAR DOWNSTOPS

Set the rear downstops so the bottoms of the rear uprights are at a specific value on the gauge.

Adjust rear downstops by turning the downstop setscrews into or out of the rear lower arms.

- **INCREASE rear downstop:** Turn IN (CW) the rear downstop screw so they protrude more below the arms.
- **DECREASE rear downstop:** Turn OUT (CCW) the rear downstop screw so they protrude less below the arms.

IMPORTANT: Measure the rear downstop under the rear upright.

SHOCK ABSORBERS



Shock absorbers, or shocks, are the suspension components that allow the wheels to keep as much contact as possible with the track surface. The XRAY NT1 has fully-independent front and rear suspension, meaning that the suspension at each corner of the car (front left, front right, rear left, rear right) moves and may be adjusted independently of the others. As such, there is a shock absorber at each corner of the car.

Damping, mounting position, spring tension, and spring preload are all characteristics that determine how the shock performs.

SHOCK SPRING RATE

Shock spring rate determines how much the spring resists compression, which is commonly referred to as the "hardness" of the spring. Different spring rates determine how much of the car's weight is transferred to the wheel relative to the other shocks. Spring rate also influences the speed at which a shock rebounds after compression. Spring rate selection depends on whether the track is fast or slow, or has high or low grip.



Spring rate is determined by the characteristics of the spring itself, and NOT by the amount of preload placed on the spring by the preload collars. Characteristics such as wire material, wire thickness, and other factors determine spring rate. Spring rate is usually expressed as a "spring weight" number that indicates how much weight (or force) is required to compress the spring by a specific amount. A spring with a higher "spring weight" number is considered "harder" since it will be more difficult to compress than a spring with a lower "spring weight" number.

XRAY shock springs are color-coded so that all springs of a specific "spring weight" have the same external colour. Note that spring colours are NOT standardized; an XRAY silver spring will not have the same spring tension as a silver spring from another manufacturer.

EFFECTS OF SPRING RATE SELECTION

| | |
|------------------------|--|
| Stiffer springs | <ul style="list-style-type: none"> • Makes the car more responsive. • Car reacts faster to steering inputs. • Stiff springs are suited for tight, high-traction tracks that aren't too bumpy. • Usually when you stiffen all of the springs, you lose a small amount of steering, and reduce chassis roll. |
| Softer springs | <ul style="list-style-type: none"> • Makes the car feel as if it has a little more traction in low grip conditions. • Better for bumpy and very large and open tracks. • Springs that are too soft make the car feel sluggish and slow, allowing more chassis roll. |

| | |
|------------------------------|---|
| Stiffer front springs | <ul style="list-style-type: none"> • Increases mid-corner and corner-exit understeer. • Increases steering under braking. • Increases the car's responsiveness, but makes it more "nervous". |
| Softer front springs | <ul style="list-style-type: none"> • Makes the car have more steering, especially mid-corner and at corner exit. • Front springs that are too soft can make the car understeer under braking. |
| Stiffer rear springs | <ul style="list-style-type: none"> • Makes the car have less rear traction, but more steering mid-corner and at corner exit. This is especially apparent in long, high-speed corners. |
| Softer rear springs | <ul style="list-style-type: none"> • Makes the car have more rear side traction mid-corner, through bumpy sections, and while accelerating (forward traction). |

| | | | |
|---------------|---|---------------|--|
| 308386 | XRAY SPRING-SET D=1.7 (25 LB) DARK-BLUE - REAR (4) | 338183 | XRAY SPRING D=1.7 (25 LB) DARK-BLUE - FRONT (2) |
| 308387 | XRAY SPRING-SET D=1.8 (30 LB) LIGHT-PURPLE - REAR (4) | 338185 | XRAY SPRING D=1.7 (28 LB) VIOLET - FRONT (2) |
| 308396 | XRAY SPRING-SET D=1.7 (28 LB) VIOLET - REAR (4) | 338186 | XRAY SPRING D=1.8 (30 LB) LIGHT-PURPLE - FRONT (2) |
| 308397 | XRAY SPRING-SET D=1.8 (33 LB) PURPLE - REAR (4) | 338187 | XRAY SPRING D=1.8 (33 LB) PURPLE - FRONT (2) |

Adjust shock spring rate by substituting different shock springs on each pair of front or rear shocks.

IMPORTANT: Each pair of front shocks or rear shocks must use the same shock springs on left and right sides.

SHOCK SPRING PRELOAD

| PRELOAD SETTING | THREADED PRELOAD COLLAR |
|-----------------|---|
| Increase | TIGHTEN collar so it moves DOWN the shock body. |
| Decrease | LOOSEN collar so it moves UP the shock body. |

Hint: File a small notch on the top of each spring collar so you can tell when you have adjusted it one full rotation.



Shock spring preload IS used for:

- Used primarily for adjusting ride height. Adjust the spring preload collar so you get the desired ride-height when the car is fully equipped, ready-to-run. For more information, see section Ride Height.
- Adjusting suspension tweak. For more information, see section Tweak.

Shock spring preload is NOT used for:

- Spring preload does not alter camber or other suspension settings or characteristics.
- Spring preload does not alter spring tension. To change spring tension, switch to a softer or harder shock spring (see Shock Spring Rate).

SHOCK POSITION

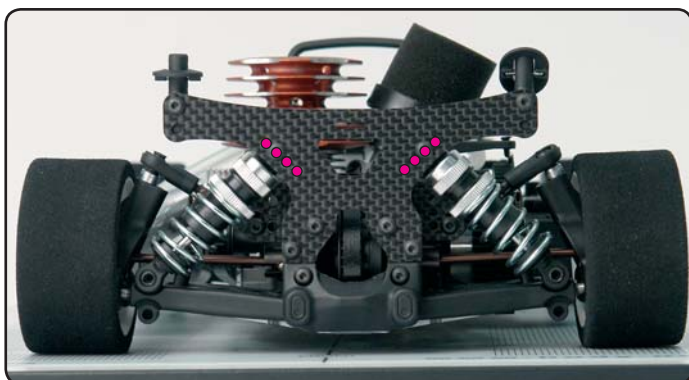

The upper and lower shock mounting positions determine how much leverage the lower suspension arm has on the shock when compressing it, and how progressive the suspension is. Different shock position settings change how the shock reacts to compression.

EFFECTS OF SHOCK POSITION ADJUSTMENT

| | |
|-----------------------------|---|
| Shocks More Inclined | <ul style="list-style-type: none"> • Makes the spring and damping softer. • Makes the car more progressive, giving a smoother feel and more lateral grip (side-bite). |
| Shocks More Upright | <ul style="list-style-type: none"> • Makes the spring and damping harder. • Makes the car have a more direct feel, but less lateral grip. |

ADJUSTING SHOCK POSITION

Adjust shock position by changing the location of the shock upper mounts on the shocktowers.

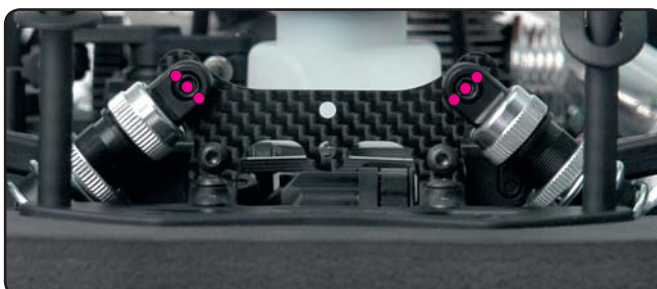

IMPORTANT: For each pair of front/rear shocks, the shock positions must be the same on left and right sides of the car.

SHOCK DAMPING

Shock damping manages the resistance of the shock to movement, as the internal shock piston moves through the shock oil when the shock compresses and rebounds.

Damping mainly has an effect on how the car behaves on bumps and how it reacts initially to steering, braking, and acceleration. Damping only comes into play when the suspension is moving (either vertical wheel or chassis movement or due to chassis roll), and loses its effect when the suspension has reached a stable position. Without damping, the shock springs would cause the shock to “pogo” or “bounce” (compressing and rebounding) until it stabilized.

When the shock is compressing or rebounding, the shock oil resists the movement of the piston through it. The amount of resistance is affected by several factors:

- Viscosity (thickness) of the shock oil
- Restriction of oil flow through the piston (affected by the number of holes in the piston)
- Velocity (speed) of the piston

Damping is affected by both shock oil and shock piston settings; getting the optimum shock damping typically requires “hands on” experience.

SHOCK DAMPING – SHOCK OIL

Shock oil is rated with a “viscosity” number that indicates the thickness of the oil, which determines how much the oil resists flowing and how much it resists the shock piston moving through it. Shock oil with a higher viscosity (for example, 300cSt oil) is thicker than shock oil with a lower viscosity (for example, 150cSt oil).

We recommend using only highest-grade XRAY Silicone Shock Oil, which is available in numerous viscosities. XRAY Silicone Shock Oil is specially formulated to be temperature-resistant and low-foaming for use in XRAY shocks.

| | | | | | | | | | | | | | | |
|--------|--------|--------|--------|--------|--------|--------|--------|--------|--------|--------|--------|--------|---------|---------|
| 359210 | 359215 | 359220 | 359225 | 359230 | 359235 | 359240 | 359245 | 359250 | 359260 | 359270 | 359280 | 359290 | 359301 | 359302 |
| 100cSt | 150cSt | 200cSt | 250cSt | 300cSt | 350cSt | 400cSt | 450cSt | 500cSt | 600cSt | 700cSt | 800cSt | 900cSt | 1000cSt | 2000cSt |

THIN

THICK

SHOCK DAMPING – SHOCK PISTONS

Shock pistons affect shock damping by affecting how easily the piston travels through the shock oil when the shock is compressing or decompressing (rebounding). The piston has holes through which shock oil flows as the piston travels up and down inside the shock body. The number of holes helps control how quickly the shock compresses or decompresses.

The shocks of the XRAY NT1 may be built with either non-adjustable or 4-step adjustable shock pistons.

- Non-adjustable pistons use a solid, 1-piece piston with a set number of holes in it. To change the shock damping, you must disassemble the shocks and replace the piston with another piston with a different number of holes.
- The XRAY adjustable shock pistons use a unique 2-piece piston assembly that can be easily adjusted to align 1–4 holes.

■ NON-ADJUSTABLE ■ ADJUSTABLE

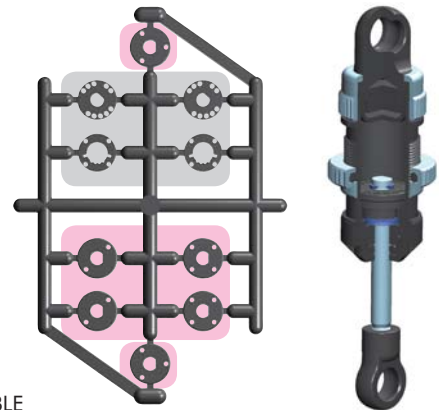

EFFECTS OF SHOCK DAMPING ADJUSTMENT

The effects of damping are often difficult to distinguish since there is an adjustment where grip is optimum. When you get away from the optimum damping setting, either softer or harder, the car will always lose grip.

The table below describes the handling effects by changing damping on one end of the car; the starting point is always the ideal “optimum.”

| | Adjusting with... | | Effect |
|-----------------------|-------------------|--------------|---|
| | Shock Oil | Piston Holes | |
| FRONT SHOCKS | | | |
| Softer damping | Thinner | More holes | <ul style="list-style-type: none"> • Slower steering response. • Decreases initial steering at corner entry. • Increases oversteer at corner exit/under acceleration. |
| Harder damping | Thicker | Less holes | <ul style="list-style-type: none"> • Faster steering response. • Increases initial steering at corner entry. • Increases understeer at corner exit/under acceleration. |

| | Adjusting with... | | Effect |
|-----------------------|-------------------|--------------|--|
| | Shock Oil | Piston Holes | |
| REAR SHOCKS | | | |
| Softer damping | Thinner | More holes | • Slower steering response. |
| | | | • Decreases rear grip at corner exit/under acceleration. |
| | | | • Increases rear grip under braking. |
| Harder damping | Thicker | Less holes | • Slower steering response. |
| | | | • Decreases rear grip at corner exit/under acceleration. |
| | | | • Increases rear grip under braking. |

ADJUSTING SHOCK DAMPING

ADJUSTING DAMPING WITH SHOCK OIL

1. Disassemble the shock.
2. Replace the oil with an oil of another viscosity.
3. Reassemble the shock.
4. Bleed the air from the shock.

ADJUSTING DAMPING WITH NON-ADJUSTABLE SHOCK PISTONS

1. Disassemble the shock.
2. Replace the shock piston with another piston with appropriate number of holes.
3. Re-fill with shock oil.
4. Reassemble the shock.
5. Bleed the air from the shock.

ADJUSTING DAMPING WITH ADJUSTABLE SHOCK PISTONS

1. Disconnect the shock lower mount from the arm.
2. Fully extend the shock rod and turn it slightly to lock the piston in the shock body.
3. Turn the shock rod to align the proper number of holes in the piston.

There are four positions (1-2-3-4 holes aligned), each of which can be felt by a slight "click" when you turn the piston rod.

- Full CW aligns 1 hole (hardest setting)
- Full CCW aligns 4 holes (softest setting)

4. Re-attach the shock lower mount to the arm.

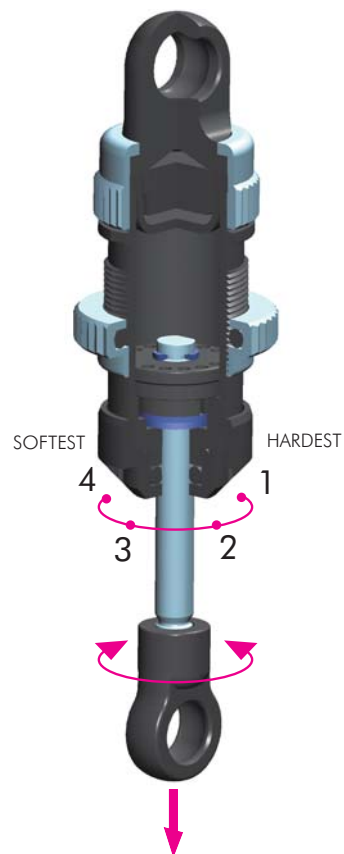

TRACK-WIDTH

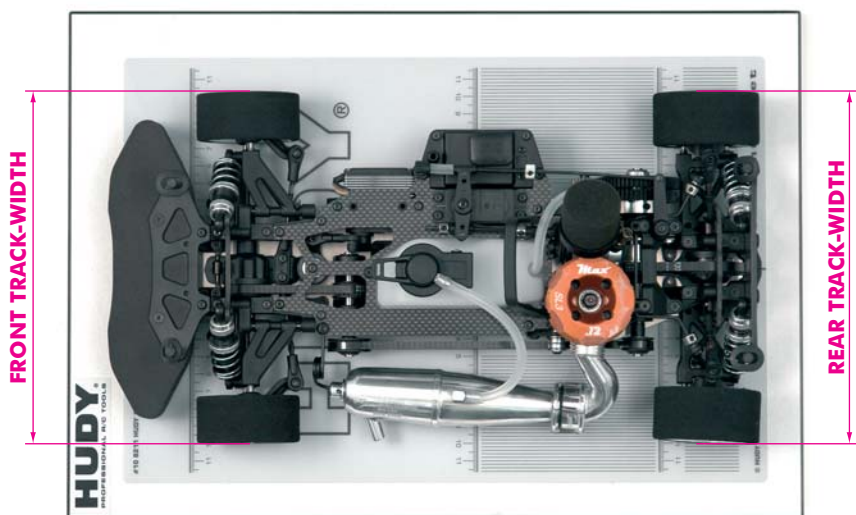

Track-width is the distance between the outside edges of the wheels, front or rear, and it affects the car's handling and steering response.

It is important that front or rear track-width is adjusted symmetrically, meaning that the left and right wheels (at one end of the car) must be the same distance from the centerline of the chassis.

EFFECTS OF TRACK-WIDTH ADJUSTMENT

| | | |
|-------------------|-----------------|---|
| FRONT TRACK-WIDTH | Wider | <ul style="list-style-type: none"> • Decreases front grip. • Increases understeer. • Slower steering response. • Use to avoid traction rolling. |
| | Narrower | <ul style="list-style-type: none"> • Increases front grip. • Decreases understeer. • Faster steering response. |
| REAR TRACK-WIDTH | Wider | <ul style="list-style-type: none"> • Increases rear grip at corner entry. • Increases high-speed on-throttle steering. • Use to avoid traction rolling. |
| | Narrower | <ul style="list-style-type: none"> • Increases grip at corner exit. • Increases high-speed understeer. • Increases front grip in hairpin turns. |

MEASURING TRACK-WIDTH

| INITIAL STEPS | SET-UP COMPONENTS |
|--|--|
| Prepare the car as follows: | Use the following set-up components: |
| <ul style="list-style-type: none"> • Shocks: Attach the shocks • Wheels: Attach the wheels | <ul style="list-style-type: none"> • Flat setup board & decal |

MEASURING FRONT TRACK-WIDTH

Measure front track-width on the outside edges of the front wheels.

1. Place the car on the flat setup board and align the centerline of the chassis with the centerline marking on the setup decal.
2. Move the car so the front wheels are resting on the graduated scale for front track-width.
3. Check the track-width value at the outer edge of each front wheel.



MEASURING REAR TRACK-WIDTH

Measure rear track-width on the outside edges of the rear wheels.

1. Place the car on the flat setup board and align the centerline of the chassis with the centerline marking on the setup decal.
2. Move the car so the rear wheels are resting on the graduated scale for rear track-width.
3. Check the track-width value at the outer edge of each rear wheel.



ADJUSTING TRACK-WIDTH

Adjust the front and rear track-width using the pivotballs in the front steering blocks, and pivotballs and rear camber link in the rear hubs.

IMPORTANT:

Make equal adjustments on both left and right sides. Track-width must be symmetrical on both left and right sides of the car.

ADJUSTING FRONT TRACK-WIDTH

Adjust front track-width using the two (2) pivotballs in the front steering blocks:

- **INCREASE front track-width (wider):** Turn OUT (CCW) both upper and lower pivotballs equally.
- **DECREASE front track-width (narrower):** Turn IN (CW) both upper and lower pivotballs equally.

NOTE: Changing front track-width will also affect the front toe setting.



ADJUSTING REAR TRACK-WIDTH

Adjust rear track-width using the two (2) lower pivotballs in the rear hubs, and also the rear upper camber link:

- **INCREASE rear track-width (wider):**
Turn OUT (CCW) both lower pivotballs equally, and lengthen the rear upper camber link.
- **DECREASE rear track-width (narrower):**
Turn IN (CW) both lower pivotballs equally, and shorten the rear upper camber link.

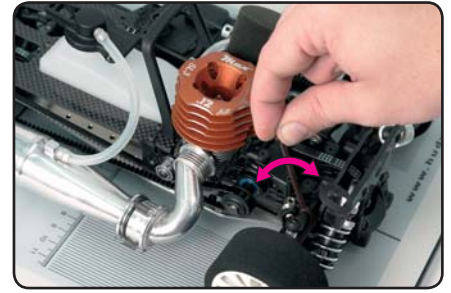
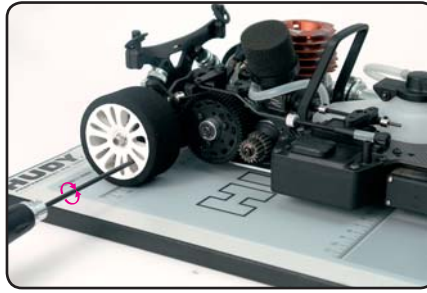

RIDE HEIGHT



Ride height is the height of the chassis in relation to the surface it is sitting on, with the car ready to run. Ride height affects the car's traction since it alters the car's center of gravity and roll center. Because of changes in suspension geometry and ground clearance, there are negative consequences to altering ride height too much.

Ride height is measured with the wheels on the car, and the car ready-to-run. Measure and adjust ride height with the car ready-to-run but without the body. Use the shock preload collars to raise and lower the ride height.

EFFECTS OF RIDE HEIGHT ADJUSTMENT

| | |
|---|---|
| Decreasing ride height (lowering the car) | <ul style="list-style-type: none"> • Increases overall grip. • Better on smooth tracks. |
| Increasing ride height (raising the car) | <ul style="list-style-type: none"> • Decreases overall grip. • Better on bumpy tracks (prevents bottoming). |

RIDE HEIGHT AND TIRES

The car's ride height decreases as the foam tires wear down to smaller diameters. The foam tires may wear at different rates front-to-back, and left-to-right, which may eventually result in an uneven ride height at all four corners and an incorrect overdrive ratio. You should try to select tire hardness to achieve even tire wear for longer races. For more information, see the tips for using foam tires.

RIDE HEIGHT AND SUSPENSION SETTINGS

Suspension settings are unaffected by the wheels/tires you put on the car, only the ride height is affected. When you use a set-up system (such as the HUDY All-In-One Set-Up Solution) to set your suspension settings, the suspension settings do not change when you put different wheels on the car. With the car sitting on the ground, it may appear that certain settings are different, but this may be due to uneven tires, or tires with different diameters. However, the settings you set using a set-up system are the true suspension settings.

MEASURING RIDE HEIGHT

| INITIAL STEPS | SET-UP COMPONENTS |
|---|---|
| Prepare the car as follows: | Use the following set-up components: |
| <ul style="list-style-type: none"> • Shocks: Attach the shocks • Wheels: Attach the wheels. Tire diameters should be: 59mm front / 60mm rear. | <ul style="list-style-type: none"> • Ride Height Gauge |

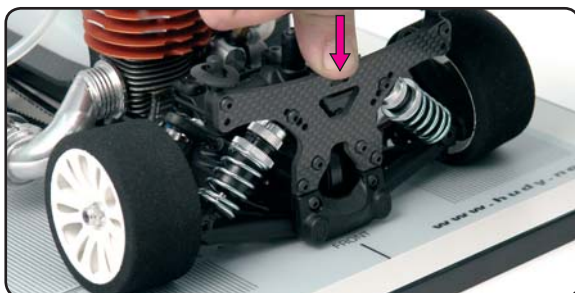

1. Place the car on the set-up board.
2. Push down and release the front and rear of the car so that the suspension settles.

RIDE HEIGHT

3. Measure the ride height using the ride height gauge at the front and rear of the car at the lowest points of the chassis.



ADJUSTING RIDE HEIGHT

Adjust ride height using spring preload only. DO NOT adjust ride height using the downstop setscrews.

| PRELOAD SETTING | THREADED PRELOAD COLLAR |
|-----------------|---|
| Increase | TIGHTEN collar so it moves DOWN the shock body. |
| Decrease | LOOSEN collar so it moves UP the shock body. |

ADJUSTING FRONT RIDE HEIGHT

Adjust front ride height by increasing or decreasing the preload on the front shock springs.

- **INCREASE (raise) front ride height:** TIGHTEN the spring preload collars on the front shocks (increasing the preload). This moves the collars DOWN the shock bodies.
- **DECREASE (lower) front ride height:** LOOSEN the spring preload collars on the front shocks (decreasing the preload). This moves the collars UP the shock bodies.

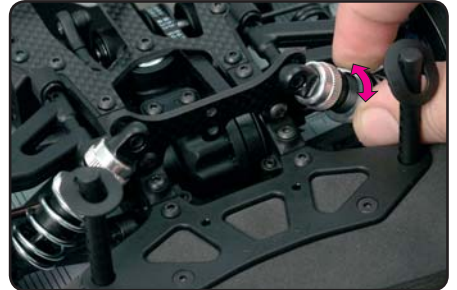

ADJUSTING REAR RIDE HEIGHT

Adjust rear ride height by increasing or decreasing the preload on the rear shock springs.

- **INCREASE (raise) rear ride height:** TIGHTEN the spring preload collars on the rear shocks (increasing the preload). This moves the collars DOWN the shock bodies.
- **DECREASE (lower) rear ride height:** LOOSEN the spring preload collars on the rear shocks (decreasing the preload). This moves the collars UP the shock bodies.

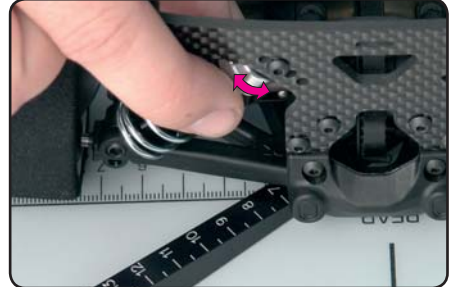

CAMBER

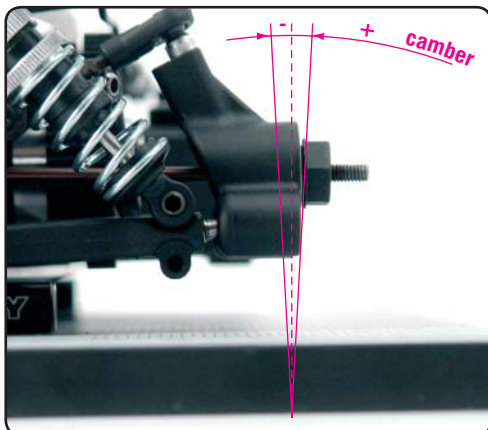

Camber is the angle of a wheel to the surface on which the car is resting (with wheels and shock absorbers mounted).

- Zero degrees (0°) of camber means that the wheel is perpendicular to the reference surface.
- Negative camber (for example, -2.0°) means that the top of the wheel is leaning inwards towards the centerline of the car.
- Positive camber (for example, $+2.0^\circ$) means that the top of the wheel is leaning outwards from the centerline of the car.

Camber affects the car's traction. Generally more negative (inward) camber means increased grip since the side-traction of the wheel increases.

Adjust front camber so that the front tires wear flat. Adjust rear camber so that the rear tires wear slightly conical to the inside. The amount of front camber required to maintain the maximum contact patch also depends on the amount of caster. Higher caster angles (more inclined) require less negative camber, while lower caster angles (more upright) require more negative camber.

MEASURING CAMBER

| INITIAL STEPS | SET-UP COMPONENTS |
|--|--|
| <p>Prepare the car as follows:</p> <ul style="list-style-type: none"> • Shocks: Attach the front and rear shocks. • Anti-roll bars: Detach front and rear anti-roll bars. • Wheels: Remove the wheels. | <p>Use the following set-up components:</p> <ul style="list-style-type: none"> • assembled set-up stands |



1. Assemble the set-up stands.
2. Mount the set-up stands on the axles.
3. Place the car on the set-up board.

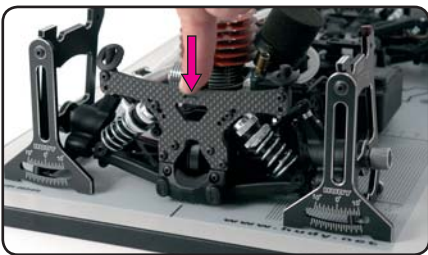

4. Push down and release the front and rear of the car so that the suspension settles.

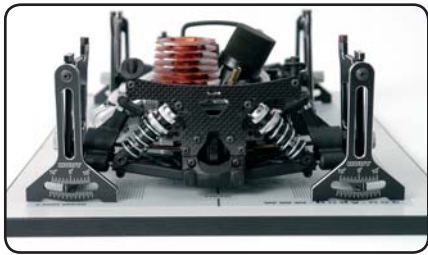

5. Read the camber setting from the camber gauge of each of the four set-up stands.



Setup Stand Camber Values

Each graduated camber mark on a setup stand indicates a 1° camber value. You should be able to set camber with a resolution of 0.5°

ADJUSTING CAMBER

Adjust the front and rear camber using the upper pivotballs in the front steering blocks, and rear camber link in the rear hubs, respectively.

IMPORTANT: Make equal adjustments on both left and right sides.

ADJUSTING FRONT CAMBER

Adjust front camber using the upper pivotball in the front steering block. Use only the top pivotball; DO NOT adjust the lower pivotball.

- **MORE NEGATIVE front camber (more inclined):** Turn IN (CW) the front upper pivotball.
- **LESS NEGATIVE front camber (more upright):** Turn OUT (CCW) the front upper pivotball.



ADJUSTING REAR CAMBER

Adjust rear camber using the rear upper camber link;
DO NOT adjust the rear lower pivotballs.

- **MORE NEGATIVE rear camber (more inclined):** SHORTEN the rear upper camber link.
- **LESS NEGATIVE rear camber (more upright):** LENGTHEN the rear upper camber link.

IMPORTANT:

After you set the camber, recheck the ride height settings. Camber and ride height settings affect each other, so be sure to check each one when you adjust the other.

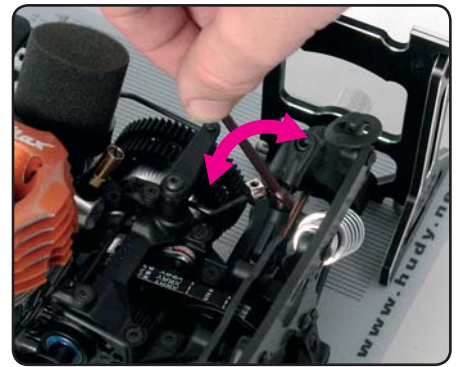

CASTER

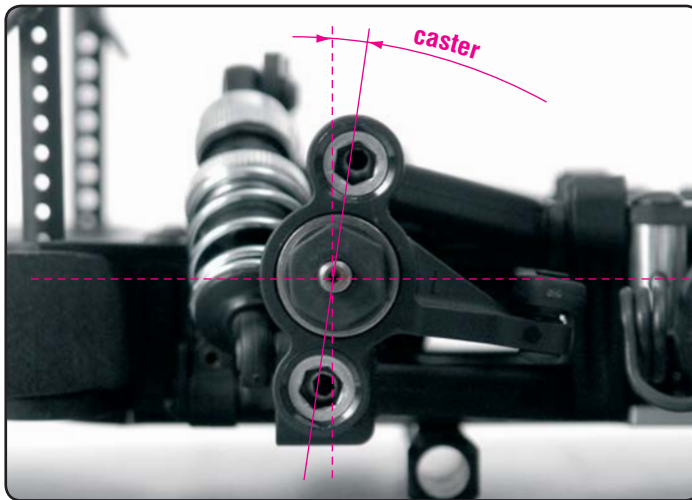

Caster describes the forward/backward angle of the front steering block with respect to a line perpendicular to the ground.

Caster angle affects on- and off-power steering, as it tilts the chassis more or less depending on how much caster is set. Generally, a lower caster angle (more upright) is better on slippery, inconsistent, and rough surfaces, and a higher caster angle (more inclined) is better on smooth, high-traction surfaces.

CAMBER VS. CASTER

Camber is all about contact patch — keeping as much tire on the ground as possible. Camber and caster are related in that caster gives an amount of effective camber change when the front wheels are turned.

A higher caster angle (more inclined) has the effect of progressively leaning the front tires into the direction of the corner as the wheels are turned. The higher (more inclined) the caster angle, the greater the effective camber change when the wheels are turned. This happens because the tops of the wheels BOTH TILT towards the inside of the corner. With the proper amount of caster this can increase steering, but if too much the tire only runs on the inside edge and loses its contact patch and grip.

Compare that with static camber angle of the wheels, which is adjusted with the car resting on a flat surface and the wheels pointed straight ahead.

Static camber adjustments primarily affect the outside wheels, since these are the wheels that bear the majority of the load during cornering. The amount of front static camber required to maintain maximum tire contact largely depends on the amount of caster used. A higher caster angle (more inclined) requires less static camber, while a lower caster angle (more upright) requires more static camber. Check how the tires wear when you change caster and re-adjust static camber if necessary until you get the desired (flat) wear on the tire.

Another effect of caster is that it tilts the chassis when the front wheels are turned. The higher the caster angle (more inclined), the more the inside wheel lifts the inside of the chassis from the ground when the wheels are turned into the corner. This tilts the chassis down to the outside, distributing more weight to the outside wheel.

EFFECTS OF CASTER ADJUSTMENT

| | |
|---|--|
| Less caster angle (more vertical) | <ul style="list-style-type: none"> • Decreases straight-line stability. • Increases steering at corner entry. • Decreases steering at mid-corner and corner exit. |
| More caster angle (more inclined) | <ul style="list-style-type: none"> • Increases straight-line stability. • Decreases steering at corner entry. • Increases steering at mid-corner and corner exit. |

Depending on the track surface and tire hardness, these effects may be different in that you may always have more steering with more caster. This is especially true for high-traction tracks and/or soft tires.

ADJUSTING CASTER

Adjust caster by installing different-thickness caster clips behind the front upper arm (on the pivot pin).

IMPORTANT: Make sure you adjust caster so it is equal on both left and right sides.

Caster angle may be adjusted by using different thicknesses of spacers ahead of and behind the upper front arm.

- **LESS caster angle (more upright):** Use MORE (or THICKER) spacers BEHIND the front upper arm (and less/thinner clips ahead of the arm).
- **MORE caster angle (more inclined):** Use LESS (or THINNER) spacers behind the front upper arm (and more/thicker clips ahead of the arm).

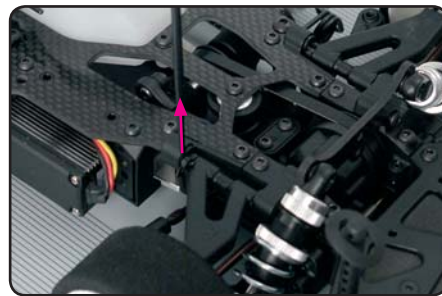

TOE

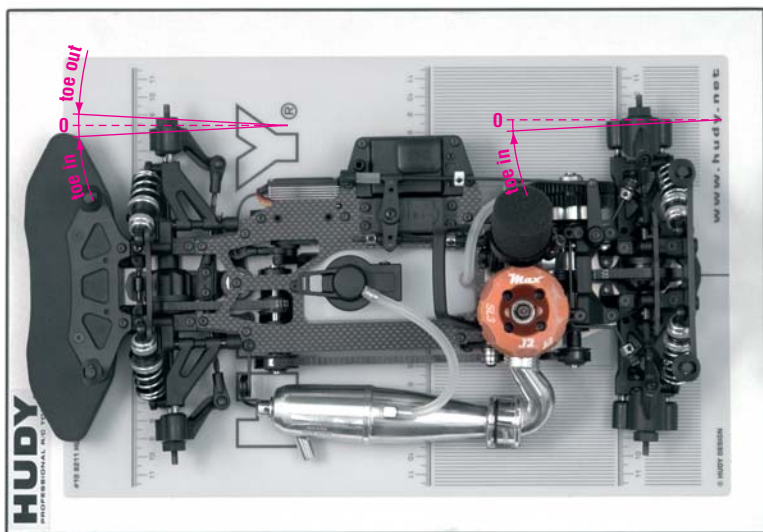

Toe is the angle of the wheels when viewed from above the car.

- Zero degrees (0°) of toe means the wheels are parallel with the centerline of the car
- Negative toe (toe-out) (e.g., -1.0°) means the forward edges of the wheels are open toward the front of the car
- Positive toe (toe-in) (e.g., +2.0°) means the forward edges of the wheels are closed toward the front of the car

Toe is used to stabilize the car at the expense of traction, as it introduces friction and therefore some slip in the tires.

- Front wheels can have either toe-in, toe-out, or be parallel.
- Rear wheels should always have toe-in; they should never have toe-out.

Rear toe-in is a primary adjustment, and will dictate the symmetry of the handling of the car.

EFFECTS OF TOE ADJUSTMENT

| | | |
|-----------|--------------------------|---|
| FRONT TOE | Increased (more toe-in) | <ul style="list-style-type: none"> • Increases understeer (decreases oversteer). • Decreases steering at corner entry. • Increases "nervousness." • Makes car more difficult to drive. |
| | Decreased (more toe-out) | <ul style="list-style-type: none"> • Decreases understeer (increases oversteer). • Increases steering at corner entry. • Increases straight-line stability. • Makes car easier to drive. |
| REAR TOE | Increased (more toe-in) | <ul style="list-style-type: none"> • Increases understeer. • Increases on-power stability at corner exit and braking at corner entry. • Less chance of losing rear traction. • Increases straight-line stability. |
| | Decreased (less toe-in) | <ul style="list-style-type: none"> • Decreases on-power stability at corner exit and braking. • More chance of losing rear traction. |

MEASURING TOE

| INITIAL STEPS | SET-UP COMPONENTS: |
|---|---|
| <p>Prepare the car as follows:</p> <ul style="list-style-type: none"> • Shocks: Attach the front and rear shocks. • Wheels: Remove the wheels. | <p>Use the following set-up components:</p> <ul style="list-style-type: none"> • assembled set-up stands • toe gauge |

PREPARING TO MEASURE TOE

1. Assemble the set-up stands.
2. Mount the set-up stands on the axles.
3. Place the car on the set-up board.

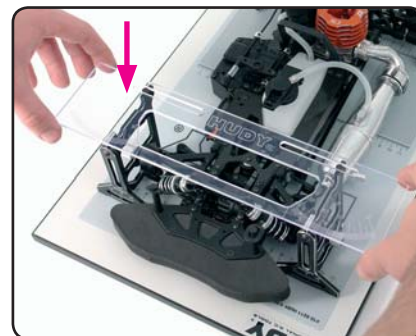

MEASURING FRONT TOE

1. With the car in the set-up system, set the toe gauge atop the front set-up stands. The pins at the top of the stands fit in the machined slots in the toe gauge.
2. To read the toe value of a front wheel, push the toe gauge to the other side until the pin on the top edge of the set-up stand hits the edge of the slot in the toe gauge. Now read the toe value on the toe gauge. The black line on the top edge of the stand points to a toe value engraved in the toe gauge.
3. Repeat for the other front wheel.



Toe Gauge Values

Each graduated mark on the toe gauge indicates a 1° toe value. You should be able to set toe with a resolution of 0.5°

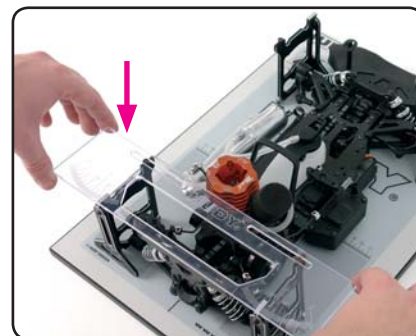

MEASURING REAR TOE

1. With the car in the set-up system, set the toe gauge atop the rear set-up stands. The pins at the top of the stands fit in the machined slots in the toe gauge.
2. To read the toe value of a rear wheel, push the toe gauge to the other side until the pin on the top edge of the set-up stand hits the edge of the slot in the toe gauge. Now read the toe value on the toe gauge. The black line on the top edge of the stand points to a toe value engraved in the toe gauge.
3. Repeat for other rear wheel.

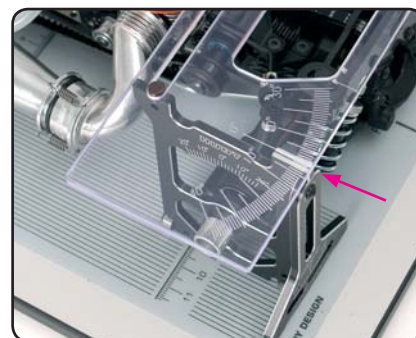

Toe Gauge Values

Each graduated mark on the toe gauge indicates a 1° toe value. You should be able to set toe with a resolution of 0.5°

ADJUSTING TOE

Adjust front and rear toe using the front steering rods and rear hub pivotballs, respectively.

IMPORTANT: Make equal toe adjustments on both left and right sides.

ADJUSTING FRONT TOE

Adjust front toe by altering the lengths of the front steering rods.

- **To turn front wheels IN (less toe-out):** LENGTHEN each steering rod equally
- **To turn front wheels OUT (more toe-out):** SHORTEN each steering rod equally

NOTE: Front toe is affected when you change the front track-width setting.

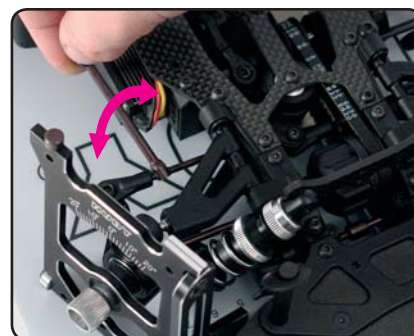

ADJUSTING REAR TOE

Adjust rear toe using the 2 lower pivotballs in each rear upright; the pivotballs must be adjusted in equal but opposite directions.

- **MORE rear toe-in (rear tires point in more):** Turn IN the forward lower pivotball, and turn OUT the rearward lower pivotball equally
- **LESS rear toe-in (rear tires point in less):** Turn OUT the forward lower pivotball, and turn IN the rearward lower pivotball equally.

IMPORTANT:

Ensure you adjust the rear lower pivotballs in equal but opposite directions, or you will change the rear camber setting.

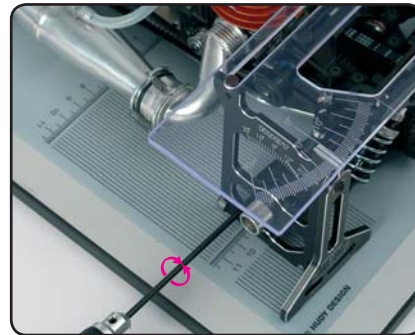

ANTI-ROLL BARS



Anti-roll bars are used to adjust the car's side (lateral) grip. They can also be used in conjunction with a softer spring rate to handle bumpy tracks more efficiently without excessive chassis roll at mid-corner. Anti-roll bars resist chassis roll and by doing so transfer wheel load from the inside wheel to the outside wheel. The stiffer the anti-roll bar, the more load is transferred. However, as the outside wheel is not able to convert the extra wheel load into extra grip, the sum of the grip of both wheels is actually reduced. This changes the balance of the car to the axle at the other end of the car; increasing the stiffness of an anti-roll bar on one particular axle (front or rear) decreases the side grip of that axle and increases the side grip of the axle at the other end of the car.

The overall traction of a car cannot be changed, but it can be balanced by distributing wheel loads. Anti-roll bars are a very useful tool to change the balance of the car. Chassis stiffness plays a very important role in the effectiveness of anti-roll bars, and a stiffer chassis makes the car more responsive to anti-roll bar changes.

EFFECTS OF ANTI-ROLL BAR ADJUSTMENT

FRONT ANTI-ROLL BAR

The front anti-roll bar affects mainly off-power steering at corner entry.

| | |
|----------------|---|
| Stiffer | <ul style="list-style-type: none"> • Decreases chassis roll. • Decreases front grip (increases rear grip). • Increases off-power steering at corner entry. • Quicker steering response. |
| Softer | <ul style="list-style-type: none"> • Increases chassis roll. • Increases front grip (decreases rear grip). • Decreases off-power steering at corner entry. • Slower steering response. |

REAR ANTI-ROLL BAR

The rear anti-roll bar affects mainly on-power steering and stability in mid-corner and at corner exit.

| | |
|----------------|---|
| Stiffer | <ul style="list-style-type: none"> • Decreases chassis roll. • Decreases rear grip (increases front grip). • Increases on-power steering. • Quicker steering response in high-speed chicanes. |
| Softer | <ul style="list-style-type: none"> • Increases chassis roll. • Increases rear grip (decreases front grip). • Decreases on-power steering. |

ADJUSTING ANTI-ROLL BARS

ADJUSTING THE FRONT ANTI-ROLL BAR

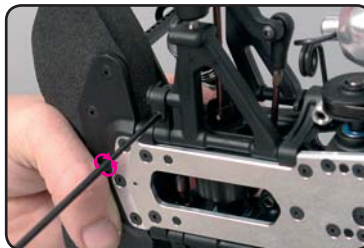

- **SOFTEST front anti-roll bar:** Turn both blades so the flat part is **horizontal**.
- **STIFFEST front anti-roll bar:** Turn both blades so the flat part is **vertical**.

You may adjust the front anti-roll bar to anywhere between the softest and stiffest settings by altering the angle as appropriate.

IMPORTANT: Ensure that both blades of the front anti-roll bar are set equally.



ANTI-ROLL BARS

ADJUSTING THE REAR ANTI-ROLL BAR

Adjust the rear anti-roll bar by moving the linkage upper pivotball on the bar:

- **SOFTER rear anti-roll bar:** Move the linkage upper pivotball outward towards the end of the bar.
- **STIFFER rear anti-roll bar:** Move the linkage upper pivotball inward away from the end of the bar.



You may also adjust the rear anti-roll bar stiffness by using rear anti-roll bar wires of different thickness:

- **SOFTER rear anti-roll bar:** Thinner wire
- **STIFFER rear anti-roll bar:** Thicker wire



TWEAK

A “tweaked” car is an unbalanced car, and has a tendency to pull to one side under acceleration or braking. Tweak is caused by an uneven wheel-load on one particular axle. You should check for suspension tweak after you have set up the suspension settings.

The method of tweak correction described here requires the use of a perfectly flat reference surface (such as the HUDY Set-up Board). However, for advanced tweak measurement and correct we recommend using the professional HUDY Tweak Station, which includes detailed explanations about tweak correction.



COMBATING TWEAK

If your car is tweaked, there are several things you can check or adjust. Check these areas in the following order:

- Chassis flatness
- Downstop settings
- Shock length and damping
- Binding parts
- Shock spring preload
- Anti-roll bars

CHASSIS FLATNESS

A twisted chassis will certainly cause a car to become tweaked. Since the chassis is the central attachment point for all suspension components, a twisted chassis will render all other suspension settings as unbalanced.

To check for a twisted chassis, remove the wheels and disconnect the springs. Place the chassis on a perfectly flat surface (such as the HUDY Set-Up Board) and see if the chassis rocks from side to side. Even a small amount of twisting will result in a tweaked car.

DOWNSTOP SETTINGS

Check downstop settings to make sure they are equal on the left and right sides of the car. For more information on downstops, see “Downstops.”

SHOCK LENGTH AND DAMPING

Check shock lengths and damping to make sure they are equal on the left and right sides of the car. You typically adjust shock length by tightening or loosening the lower pivot on the shock rod. Damping adjustment varies depending on the type of shock absorber.

BINDING PARTS

Make sure that all suspension components move freely without binding; this includes suspension arms and pins, pivotballs, ball cups, etc.

MEASURING & CORRECTING TWEAK

Measure and correct chassis tweak by first adjusting shock preload, and then by adjusting the anti-roll bars.

| INITIAL STEPS | SET-UP COMPONENTS |
|---|--|
| Prepare the car as follows: | Use the following set-up components: |
| <ul style="list-style-type: none"> • Shocks: Attach the shocks • Anti-roll bars: Disconnect the front and rear anti-roll bars (initially). • Wheels: Attach the wheels. Make sure left/right pairs of tires are the same diameter (59mm front / 61mm rear). | <ul style="list-style-type: none"> • Flat setup board |

CORRECTING REAR TWEAK – STEP 1: SHOCK PRELOAD

Determine if the REAR of the car is tweaked by checking at the FRONT of the car. Correct rear suspension tweak by adjusting preload on the FRONT shock springs.

1. Lift and drop the front and rear ends of the car a few cm's to let the suspension settle.
2. Place a pointed tool underneath the FRONT end of the chassis at its middle point, and lift the front end. If one FRONT wheel lifts before the other, the REAR end of the car is tweaked from the rear shock preload settings.

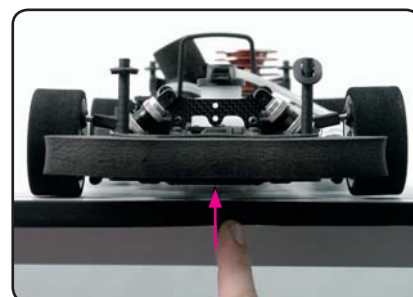

3. Adjust the preload on the REAR springs until both front wheels lift at the same time.

Increase the preload on the REAR spring diagonally across from the FRONT wheel that lifted first, and decrease the preload on the other rear spring. Adjust both rear springs in equal but opposite directions, otherwise you will change the rear ride height.

Example: If the front right wheel lifts first, INCREASE the preload on the rear left spring, and DECREASE the preload on the rear right spring by an equal but opposite amount.

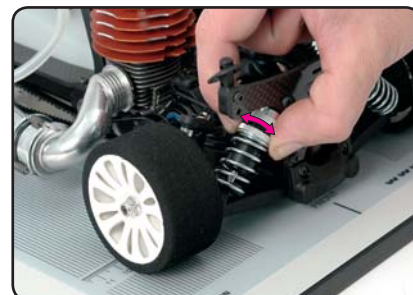

CORRECTING REAR TWEAK – STEP 2: ANTI-ROLL BAR

After you have corrected rear tweak by adjusting shock spring preload, reattach the rear anti-roll bar, re-check rear tweak, and correct it by adjusting the rear anti-roll bar linkages.

4. Reconnect the rear anti-roll bar.
5. Place a pointed tool underneath the FRONT end of the chassis at its middle point, and lift the front end. If one FRONT wheel lifts before the other, the REAR end of the car is tweaked from the rear anti-roll bar.
6. Adjust the lengths of the rear anti-roll bar linkages until both front wheels lift at the same time.

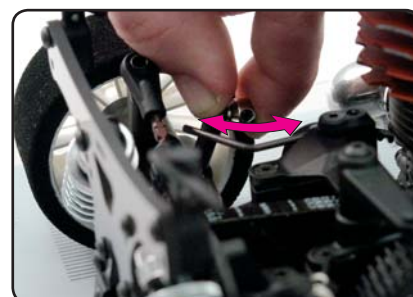

INCREASE the length of the rear anti-roll bar linkage diagonally across from the FRONT wheel that lifted first, and decrease the length of the other linkage. Adjust both linkages in equal but opposite directions.

Example: If the front right wheel lifts first, INCREASE the length of the rear left linkage, and DECREASE the length of the rear right linkage by an equal but opposite amount.

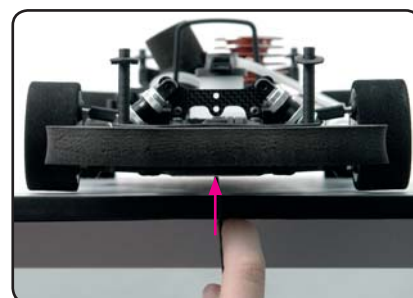

CORRECTING FRONT TWEAK – STEP 1: SHOCK PRELOAD

Determine if the FRONT of the car is tweaked by checking at the REAR of the car. Correct front suspension tweak by adjusting preload on the REAR shock springs.

1. Lift and drop the front and rear ends of the car a few cm's to let the suspension settle.
2. Place a pointed tool underneath the REAR end of the chassis at its middle point, and lift the rear end. If one REAR wheel lifts before the other, the FRONT end of the car is tweaked from the front shock preload settings.
3. Adjust the preload on the FRONT springs until both rear wheels lift at the same time.

Increase the preload on the FRONT spring diagonally across from the REAR wheel that lifted first, and decrease the preload on the other rear spring.

Adjust both front springs in equal but opposite directions, otherwise you will change the front ride height.

Example: If the rear right wheel lifts first, INCREASE the preload on the front left spring, and DECREASE the preload on the front right spring by an equal but opposite amount.

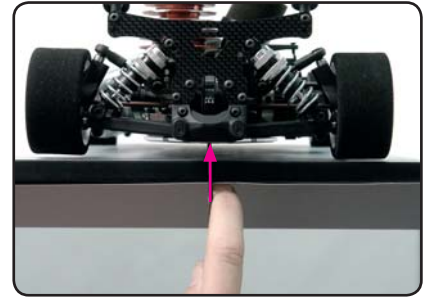

CORRECTING FRONT TWEAK – STEP 2: ANTI-ROLL BAR

After you have corrected front tweak by adjusting shock spring preload, reattach the front anti-roll bar, re-check rear tweak, and correct it by adjusting the eccentric adjustor.

4. Reconnect the front anti-roll bar.
5. Place a pointed tool underneath the REAR end of the chassis at its middle point, and lift the rear end. If one REAR wheel lifts before the other, the FRONT end of the car is tweaked from the front anti-roll bar.
6. Loosen the lower setscrews in the left and right front anti-roll bar mounts. Adjust one or both eccentric cams until both rear wheels lift from at the same time. Re-tighten the setscrew(s) to secure the adjusting cam(s).

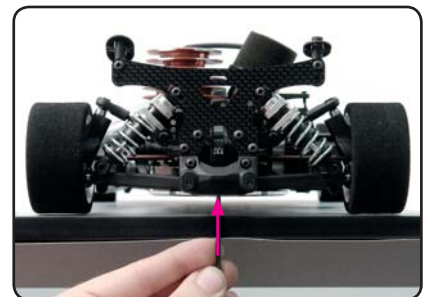
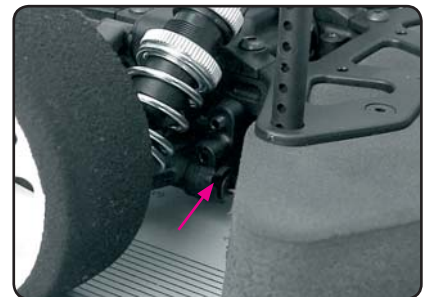

XCA CLUTCH

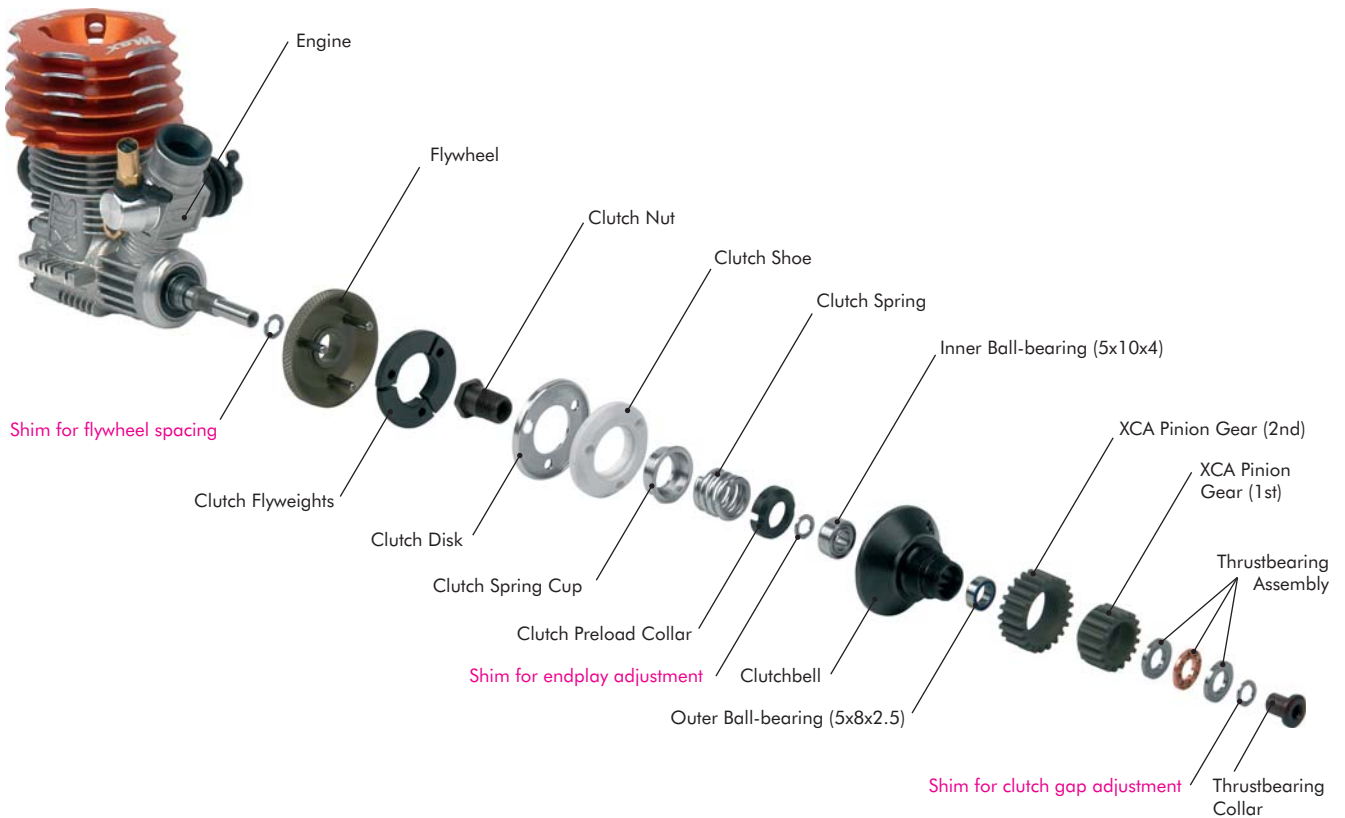

The XCA (XRAY Centrifugal-Axial) Clutch must be properly set up before driving the car the first time. A properly set up clutch will have a dramatic impact on the performance and drivability of the NT1.

It is important to note that there are many factors that may affect engine and clutch performance. Factors such as proper engine tuning, proper clutch assembly, clutch gap, and clutch endplay can all affect clutch performance.

There are three settings on the XCA clutch: clutch spring preload, clutch gap, and clutchbell endplay. Each of these settings is adjusted independently of the others.

- Clutch spring preload is adjusted using the clutch preload collar.
- Clutch gap and clutchbell endplay are adjusted using different shims.

BUILDING AND MAINTAINING THE XCA CLUTCH

When building the XCA clutch, it is very important to shim it properly for proper operation and long life. An improperly-built clutch may cause excessive slip, too early or too late engagement, engine bogging, and premature clutch failure.

GREASING AND OILING

The thrustbearing in the XCA clutch should be re-greased at least once every 30 minutes, or more often if you run on dirty tracks or your car goes off the track often. We recommend using a thick, high-tack grease such as graphite grease. The ball-bearings in the XCA clutch should be oiled regularly with a good, light bearing oil. The ball-bearings are subjected to high heat for extended periods, and have a tendency to get "rusty" after a short time (which may lead to failure if not oiled).

THRUSTBEARING INSTALLATION

The thrustbearing has two plates — one with a larger dimensions, and one with a smaller dimensions. The plate with larger dimensions **MUST** go towards the flywheel.

IMPORTANT WARNING:
It is extremely important to set the proper clutch gap and endplay, or you risk premature thrustbearing and engine failure.

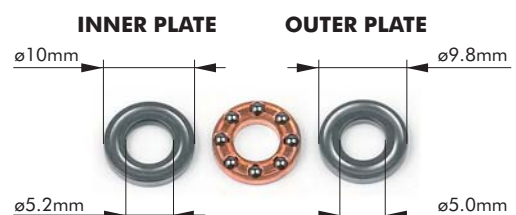

FLYWHEEL SHIMMING

When installing the XCA Clutch on the engine crankshaft, the flywheel must be properly shimmed outward from the engine so the crankshaft protrudes the proper amount. This will affect other adjustments such as clutch spring preload, clutch gap, and clutchbell endplay.

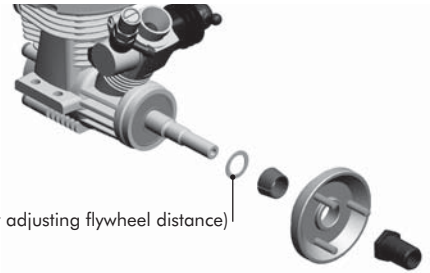

ADJUSTING FLYWHEEL DISTANCE

Flywheel – Initial Setting: crankshaft extends +9.0mm beyond clutch nut

Place large diameter shims behind the flywheel cone so that the crankshaft extends 9.0mm beyond the end of the clutch nut.

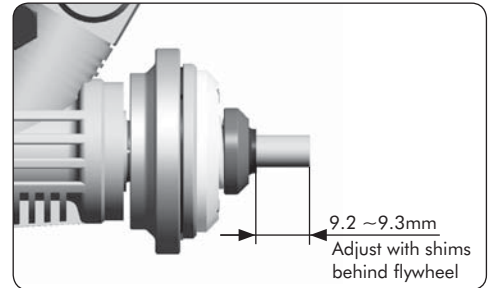

CLUTCH SPRING PRELOAD

Clutch spring preload affects the point at which the clutch engages, and is altered by tightening or loosening the clutch spring preload collar.

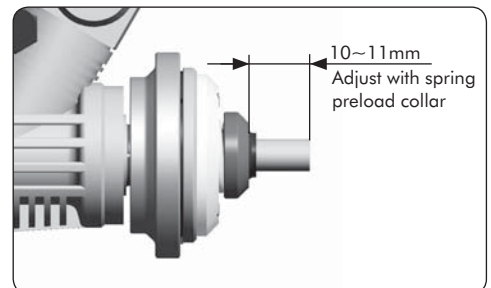

EFFECTS OF CLUTCH SPRING PRELOAD

| | |
|--|--|
| <p>Lighter Preload (looser collar)</p> | <ul style="list-style-type: none"> • Earlier engagement • Better on slippery tracks |
| <p>Heavier Preload (tighter collar)</p> | <ul style="list-style-type: none"> • Later engagement • Better on smooth, high-traction tracks |

ADJUSTING CLUTCH SPRING PRELOAD

Clutch Spring Preload – Initial Setting: 10 ~ 11 mm from end of crankshaft

Set the clutch spring preload collar to an initial value of **10 ~ 11 mm** from the end of the crankshaft to the outer edge of the collar. This is an initial value **ONLY** and must be adjusted at the track.

Adjust clutch spring preload by loosening or tightening the clutch spring preload collar.

Preload Adjustment without Disassembly (at the track)

After initial adjustment during the building phase, you can easily adjust the clutch spring preload at the track without disassembling the car or clutch.

1. Ensure the engine is stopped.
2. Find the small hole in the clutchbell near the 2nd gear pinion.
3. Rotate the flywheel until you see the slotted preload collar through the clutchbell hole.
4. Insert a small hex wrench through the hole, and push into the slot of the preload collar inside.
5. Holding the hex wrench securely so the preload collar does not move, **rotate the flywheel** to tighten or loosen the preload collar.

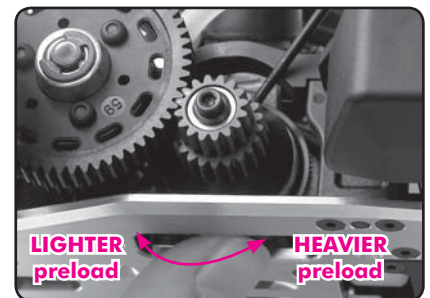
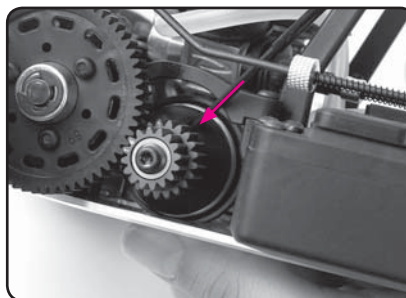

| | |
|---|----------------------------|
| Lighter Preload (looser collar) | Rotate flywheel CW |
| Heavier Preload (tighter collar) | Rotate flywheel CCW |

CLUTCH GAP

Clutch gap is the amount that the clutch shoe moves before it contacts the clutchbell. This affects the WAY that the clutch engages more than WHEN it engages.

Clutch gap must be adjusted BEFORE clutchbell endplay, and is done with only the outermost (smaller) ball-bearing and thrustbearing assembly installed; DO NOT install the innermost (larger) ball-bearing.

EFFECTS OF CLUTCH GAP ADJUSTMENT

| | |
|--------------------|--|
| Larger gap | <ul style="list-style-type: none"> • Harder engagement • More sudden acceleration • Better on a wider track or high-traction track • Puts excess stress on the clutch components, especially the thrustbearing |
| Smaller gap | <ul style="list-style-type: none"> • Softer engagement • Smoother acceleration • Better on a tighter track or a track with low traction • May result in engine bogging and premature clutch shoe wear |

ADJUSTING CLUTCH GAP

Clutch Gap – Initial Setting: 0.6–0.7mm

In the images shown here, clutch gap is the difference between values A and B. You adjust clutch gap by placing shims (medium size) on the thrustbearing collar in front of the thrustbearing assembly.

1. Install only the clutchbell, outermost ball-bearing (small) and thrustbearing assembly on the engine crankshaft; DO NOT install the innermost ball-bearing (large).
2. Push the clutchbell onto the clutch shoe, and then measure the distance A as indicated.
3. Pull the clutchbell away from the clutch shoe, and then measure the distance B as indicated.
4. The clutch shoe clearance is calculated as A–B; the initial clearance value is **0.6–0.7mm**

You can easily calculate the thickness of shims required to set the correct clearance value.

$$\text{Thickness of shims required (in mm)} = A - B - 0.7$$

Example:

For example, using the values A=5.5mm, B=4.5mm
Shim thickness = 5.5-4.5-0.7=0.3mm

5. Place the proper amount of shims directly onto the thrustbearing collar, followed by the thrustbearing assembly (as shown).

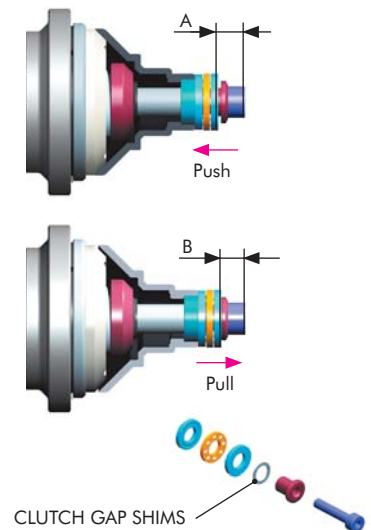

CLUTCHBELL ENDPLAY

Clutchbell endplay is the amount that the clutchbell moves along the crankshaft. Endplay should be adjusted to a minimal amount, and the clutchbell should rotate freely without binding.

Endplay must be adjusted AFTER clutch shoe clearance, and is done with the clutch fully built (including all bearings, spacers, etc.).

EFFECTS OF EXCESSIVE CLUTCHBELL ENDPLAY

When the clutch is disengaged, the thrustbearing plates are further apart. When the clutch engages, the thrustbearing plates travel further before they are 'sandwiched' together. By traveling further, more force is built up so when the clutch engages, the thrustbearing has more force suddenly applied to it.

Too much clutchbell endplay will cause premature thrustbearing wear and eventual failure.

ADJUSTING CLUTCHBELL ENDPLAY

Clutchbell Endplay – Default Setting: minimal (0.05 ~ 0.15mm)

Adjust the clutchbell endplay to a minimal amount (0.05 ~ 0.15mm) so that there is only a slight amount of movement detectable. The clutchbell should rotate freely.

1. Set the clutch shoe clearance before adjusting clutchbell endplay.
2. Remove the thrustbearing and clutchbell assemblies (including all ball-bearings).
3. Push/pull the clutchbell along the crankshaft to measure the axial endplay. There should be minimal movement (0.05 ~ 0.15mm).
4. If there is excessive endplay, remove the thrustbearing and clutchbell assemblies (including all ball-bearings) and place shims (small size) over the end of the crankshaft, in front of the clutch nut as indicated.
5. Reassemble the clutch.
6. Repeat steps 3–5 until there is minimal endplay.
7. Spin the clutchbell. It should spin freely without binding or dragging.

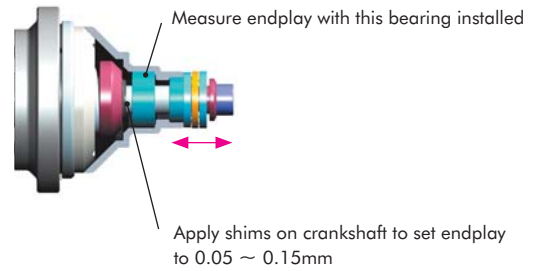

CLUTCH SHOES

XRAY offers different clutch shoes for XCA clutch to change the characteristics of the clutch and also wear and durability.

EFFECTS OF DIFFERENT CLUTCH SHOES

#338574 Clutch Shoe - White

- softer material
- higher initial bite, but more slippage
- more wear

#338575 Clutch Shoe - Yellow

- harder material
- less clutch slippage
- less wear



2-SPEED TRANSMISSION

The NT1 is equipped with a 2-speed transmission, allowing for explosive acceleration and high top speeds. The 2-speed is controlled by centrifugal force. The 1st gear drives the layshaft through the 1-way bearing and the layshaft drives the front and rear transmissions. At a certain RPM of the layshaft, the 2-speed shoes overcome the spring load binding them and they move outward where they contact and “grab” the 2nd speed drum, thereby engaging 2nd gear; the 1st gear freewheels on its 1-way bearing. As speed decreases, the spring load at some point overcomes the centrifugal force and returns the 2-speed shoes onto the layshaft, thereby re-engaging 1st gear.

The 2-speed transmission in the XRAY NT1 may be adjusted for shift point and shoe gap:

- Shift-point screws determine when the transmission shifts between 1st and 2nd gear
- Gap setting setscrews adjust the gap between the 2-speed shoes and the 2nd gear drum



SHIFT POINT

The 2-speed transmission has spring-loaded shift-point screws that allow you to fine-tune the point at which the transmission shifts between 1st and 2nd gear.

Determining the best shift point is mostly done through observation of the car as you drive it. You should be able to hear a change in engine tone as the transmission shifts from 1st to 2nd gear.

There are three considerations when setting the shift point:

- **When to shift:**
Relates to power/torque of the engine. Try to set the shift point before the engine “winds out.”
- **Where to shift:**
Relates to specific tracks. The transmission should not shift into 2nd gear right before difficult corners or sections — this will lead to inconsistency and tendency to overshoot those corners or misdrive those sections. Adjust the shift point so the car is easy to drive on the particular track.
- **Gear ratio:**
Gear ratio will affect the shift point setting. Ideally, the engine should stay well within its maximum powerband when shifting from 1st to 2nd gear. This is a matter of experimentation and experience.

| | |
|---|--|
| Earlier shift point (looser screws) | <ul style="list-style-type: none"> • 2nd gear engages earlier • Lower engine RPM and engine tone before 2nd gear engages |
| Later shift point (tighter screws) | <ul style="list-style-type: none"> • 2nd gear engages later • Higher engine RPM and engine tone before 2nd gear engages |

ADJUSTING SHIFT POINT

Shift-point Screws – Initial Setting : Top of screw head flush with hole edge

Initially set the two spring-loaded shift-point screws so the top edges of the screw heads are flush with the bottom edges of the holes. Both screws must be set equally.

You can adjust shift point with the two spring-loaded shift-point screws.

- **LATER shifting:** TIGHTEN both shift-point screws equally.
- **EARLIER shifting:** LOOSEN both shift-point screws equally.

IMPORTANT: Make equal adjustments on both shift point screws.

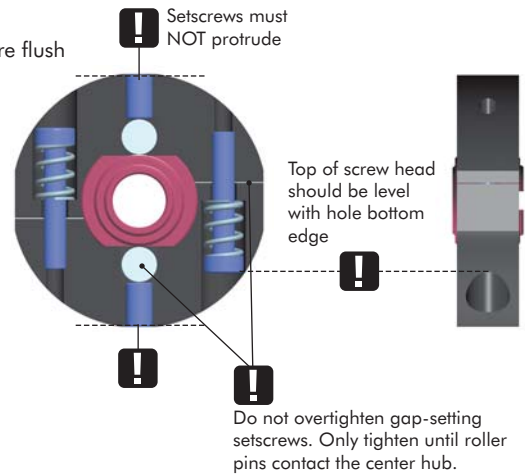

TRANSMISSION SHOE GAP

The 2-speed transmission shoes have gap-setting setscrews that allow you to adjust the gap between the shoes and the 2nd gear drum. Always adjust the shoe gap to minimum, without the shoes touching the 2nd gear drum.

The shoe gap should be checked and adjusted periodically to compensate for wear.

ADJUSTING TRANSMISSION SHOE GAP

Transmission Shoe Gap – Default Setting: 1/2 turn loose (from tight)

When building the 2-speed shoe assembly, set the gap so that the two shoes are equal distance from the 2nd gear drum.

1. Assemble the 2nd gear shoe assembly, and set both gap-setting setscrews equally so that each one just lightly touches the central adaptor. The setscrews MUST NOT protrude beyond the shoes.
2. Install the drive pin in the layshaft.
3. Slide the 2nd gear shoe assembly onto layshaft and seat it over the pin.
4. Slide the 2nd gear onto the layshaft; the drum goes over the 2nd gear shoes. There should be equal but minimal spacing between the 2-speed shoes and the inside of the 2nd gear drum.
5. Rotate the 2nd gear until you can see a gap-setting setscrew through the hole in the drum.
6. Insert a hex key through the hole and into the setscrew.
7. Tighten the gap-setting setscrew until the 2-speed shoe just touches the inside of the alu. 2nd gear drum.
8. Loosen the setscrew by 1/2 turn (CCW).
9. Repeat steps 5–8 for the other shoe; be careful not to adjust the same shoe twice.
10. Spin the 2nd gear; it should spin freely without binding or dragging.
11. Install the 1st gear.

Adjust the gap by loosening or tightening both setscrews equally:

- **LARGER gap (shoes further from drum):** LOOSEN both setscrews equally.
- **SMALLER gap (shoes closer to drum):** TIGHTEN both setscrews equally.

IMPORTANT: Make equal adjustments on both gap-setting setscrews.

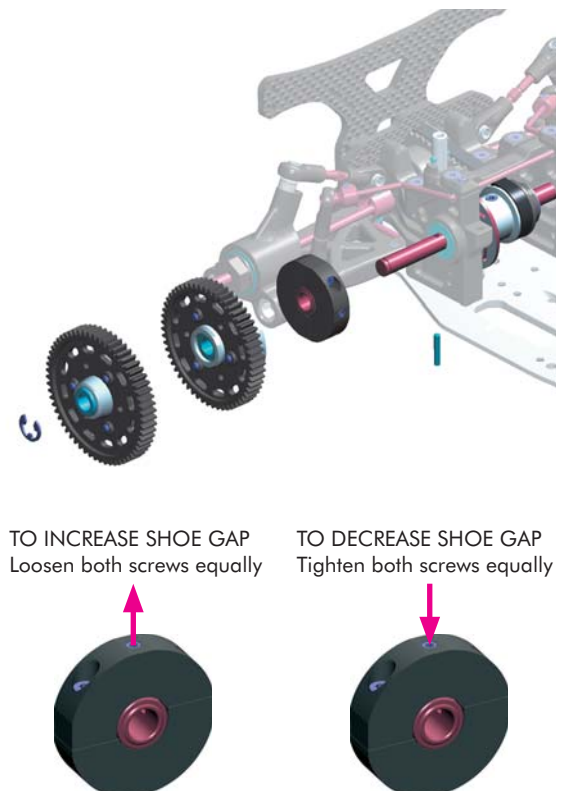

MULTI-FLEX TECHNOLOGY™

XRAY's innovative Multi-Flex Technology™ (MFT™) was originally designed for 1/10 electric touring cars, and has resulted in some of the most significant milestones in touring car development in the past few years.

The optional MFT™ 1-piece engine mounting system for the NT1 allows you to set up and adjust the NT1 chassis stiffness in the engine bay to suit various racing conditions or driving styles.

The standard 2-piece engine mount was designed and tested to allow the right amount of chassis flex to suit most driving styles and racing conditions. For specific racing conditions or driving styles, the middle of the chassis can be additionally reinforced by installing optional MFT™ 1-piece engine mount which features reinforcing legs both front and rear, reinforcing the chassis and stiffening the flex. The MFT 1-piece engine mount can be additionally mounted using graphite braces to the rear bulkheads and/or to the front holders next to the battery packs, creating a very solid and stiff platform.

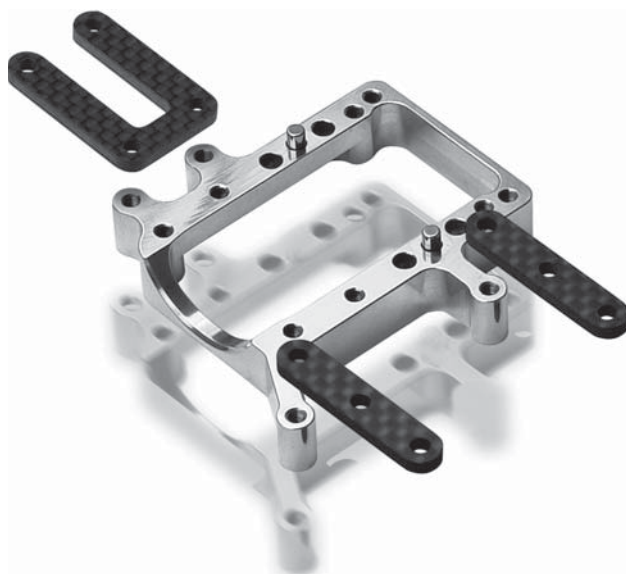

EFFECTS OF MFT™ ADJUSTMENT

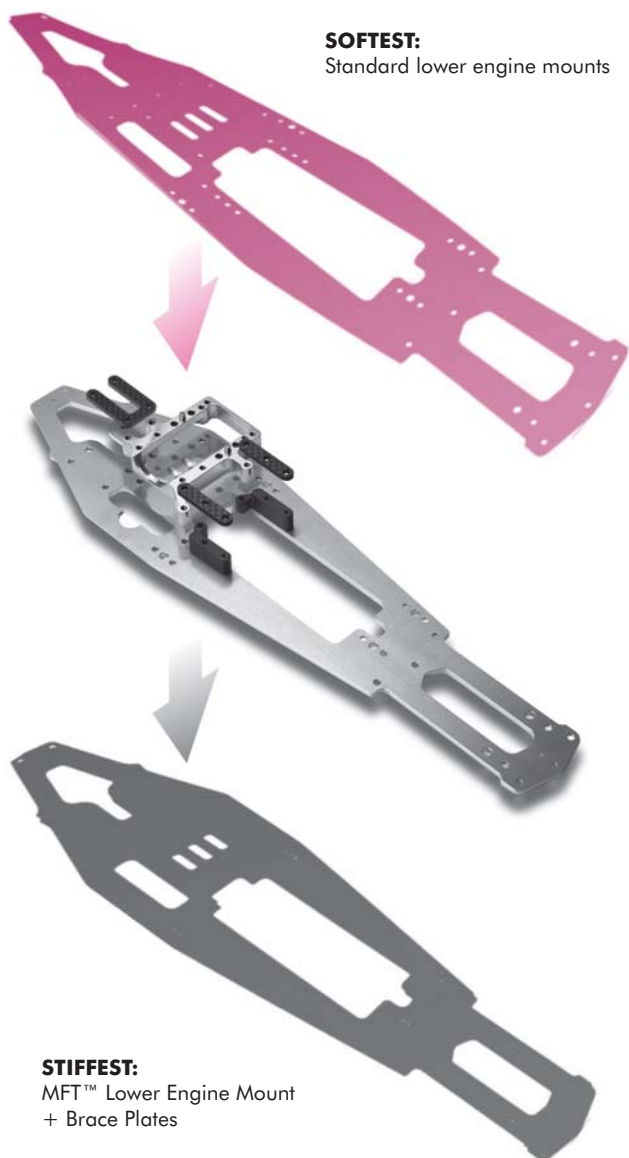

ADJUSTING CHASSIS STIFFNESS WITH MFT™ 1-PIECE ENGINE MOUNT

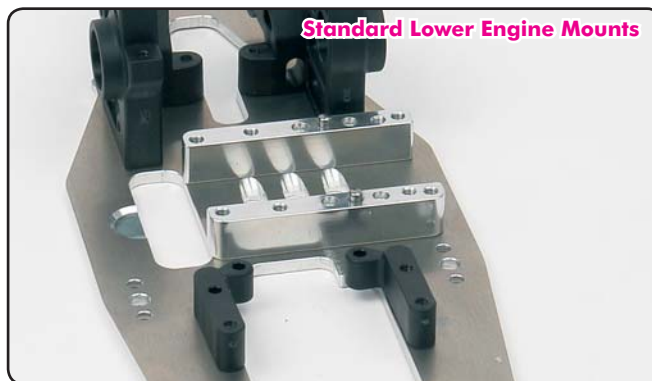

Standard Lower Engine Mounts

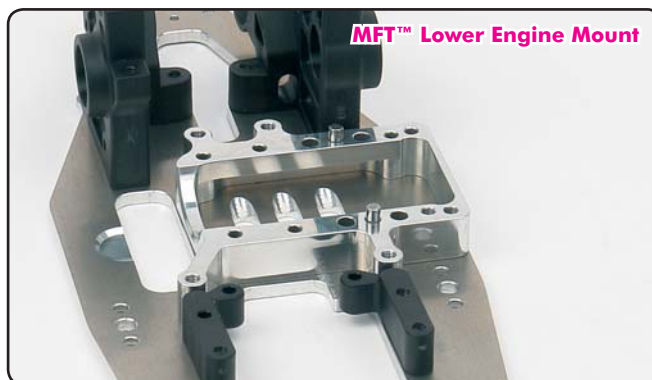

MFT™ Lower Engine Mount

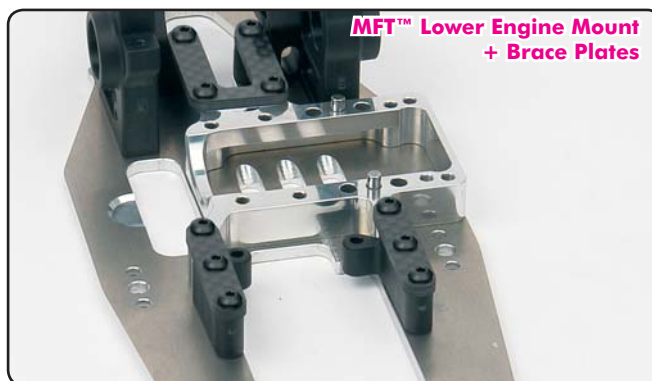

MFT™ Lower Engine Mount + Brace Plates

ROLL CENTER

A “roll center” is a theoretical point around which the chassis rolls, and is determined by the design of the suspension. Front and rear suspensions normally have different roll centers. The “roll axis” is the imaginary line between the front and rear roll centers.

The amount that a chassis rolls in a corner depends on the position of the roll axis relative to the car’s center-of-gravity (CG). The closer the roll axis is to the center of gravity, the less the chassis will roll in a corner. A lower roll center will generally produce more grip due to the chassis rolling, and the outer wheel “digging in” more.

Roll-centers have an immediate effect on a car’s handling, whereas anti-roll bars, shocks and springs require the car to roll before they produce an effect.

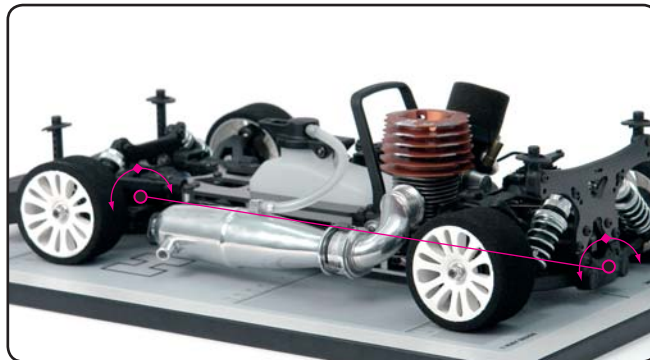

ROLL CENTER BASICS

Here are some basic facts about roll center (RC) and center-of-gravity (CG):

- Roll center (RC) is the point around which the car rolls.
- Each end of the car (front and rear) has its own roll center.
- Center-of-gravity (CG) is where all cornering force is directed.
- RC and CG are (ideally) in the middle (left-right middle) of the car.
- RC is vertically below the CG in cars.
- More chassis roll equals more grip

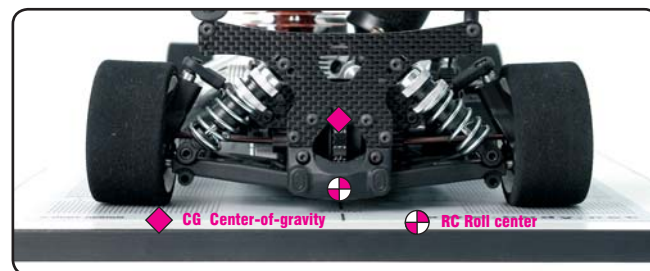

ROLL CENTER IN ACTION

When cornering, centrifugal force is applied to the car’s CG, which tends to push the car to the outside of a corner. This causes the CG to rotate around the RC. Since the RC is below the CG, cornering force causes the car to rotate AWAY from the force. Hence, the car rolls to the OUTSIDE of the corner.

- When the RC is far away from CG (lower RC), when the car corners the CG has more leverage on the RC, so the car will roll more.
- When the RC is closer to CG (higher RC), when the car corners the CG has less leverage on the RC, so the car will roll less.
- If the RC was right on top of the CG, when the car corners the CG has no leverage on the RC, so the car would not roll at all.
- Depending on what the car is doing, you will want one end or the other to roll more or less. You change the height of the RC accordingly to make it closer or further from the CG (which for all intents is a fixed point).

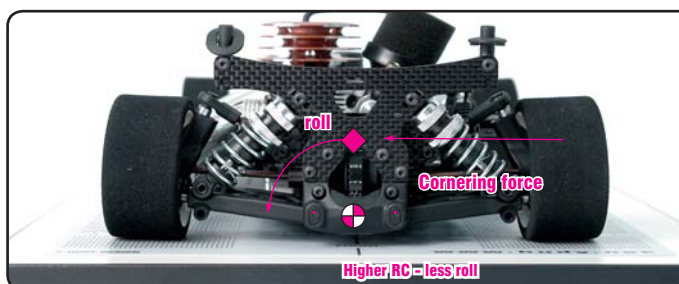
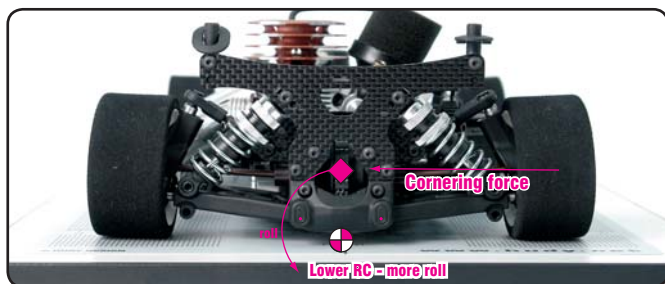

EFFECTS OF ROLL CENTER ADJUSTMENT

FRONT ROLL CENTER

Front roll center has most effect on on-throttle steering during mid-corner and corner exit.

| FRONT ROLL CENTER | EFFECT |
|-------------------|--|
| Lower | <ul style="list-style-type: none"> • Increases on-throttle steering. • Decreases car’s responsiveness. • Decreases weight transfer at front of car, but increases grip. • Increases chassis roll. • Better on smooth, high-traction tracks with long fast corners. |
| Higher | <ul style="list-style-type: none"> • Decreases on-throttle steering. • Increases car’s responsiveness. • Increases weight transfer at front of car, but decreases grip. • Decreases chassis roll. • Use in high-grip conditions to avoid traction rolling. • Better on tracks with quick direction changes (chicanes). |

REAR ROLL CENTER

Rear roll center affects on- and off-throttle situations in all cornering stages.

| Rear Roll Center | Effect |
|------------------|--|
| Lower | <ul style="list-style-type: none"> Increases on-throttle grip. Decreases weight transfer at rear of car, but increases grip. Increases grip, decreases rear tire wear. Increases chassis roll. Use to avoid traction rolling at corner entry (increases rear grip). Better on low-traction tracks. |
| Higher | <ul style="list-style-type: none"> Decreases on-throttle steering. Increases weight transfer at front of car, but decreases grip. Increases car's responsiveness. Decreases chassis roll. Use in high-grip conditions to avoid traction rolling in mid-corner and corner exit. Better on tracks with quick direction changes (chicanes). |

ADJUSTING ROLL CENTER

Adjusting the front or rear roll center on the NT1 is the best way to change mid-corner grip at either end of the car, as well as to balance out the overall grip between the front and rear.

- Use the same settings on the left and right sides of the car.
- Each matched pair of roll center inserts (at ends of a pin) must have the same position.
- Changing roll center settings impacts several other settings on the car, such as downstops, camber, and ride height.

When changing front or rear roll center, re-check your other settings.

ADJUSTING FRONT ROLL CENTER

Adjust front roll center by changing the front upper pivot pin inserts.

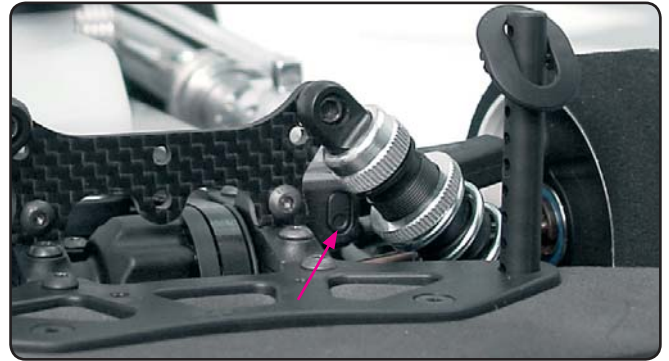

| Effect on Front Roll Center | Lowest ← → Highest | | | |
|------------------------------------|--------------------|------|------|------|
| Front Upper Insert Position | | | | |
| | +1.5 | +0.5 | -0.5 | -1.5 |

ADJUSTING REAR ROLL CENTER

Rear roll center on the XRAY NT1 can be adjusted in two manners:

- LARGE ADJUSTMENTS:** Change the rear lower pivot pin inserts.
- FINE TUNING:** Change the inner and outer mounting positions of the rear camber link

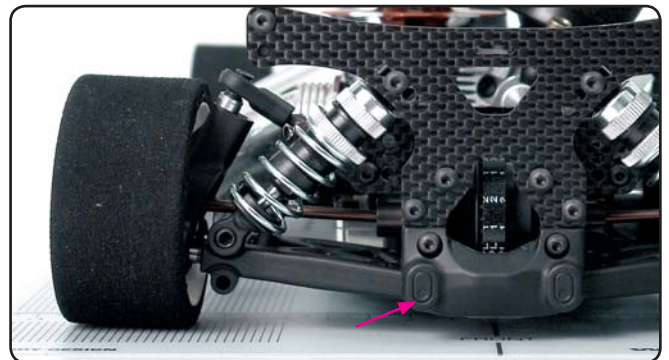

LARGE REAR ROLL CENTER ADJUSTMENTS

Make large adjustment to rear roll center by changing the rear lower pivot pin inserts.

| Effect on Rear Roll Center | Lowest ← → Highest | | | |
|-----------------------------------|--------------------|------|------|------|
| Rear Lower Insert Position | | | | |
| | -1.5 | -0.5 | +0.5 | +1.5 |

FINE REAR ROLL CENTER ADJUSTMENTS

Make finer adjustment to rear roll center by changing the rear upper camber link mounting positions.

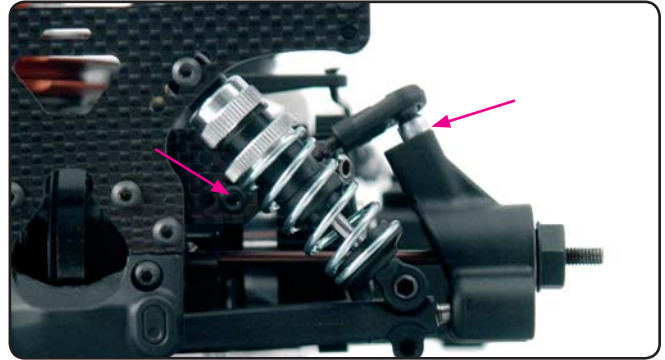

| REAR ROLL CENTER TOWER (camber link inner mounting positions) | | |
|---|--|--------------------------------|
| | <p>Lower holes (inner or outer)</p> | <p>Higher rear roll center</p> |
| | <p>Upper holes (inner or outer)</p> | <p>Lower rear roll center</p> |
| REAR UPRIGHT (camber link outer mounting positions) | | |
| | <p>MORE (or thicker) shims below linkage</p> | <p>Higher rear roll center</p> |
| | <p>FEWER (or thinner) shims below linkage</p> | <p>Lower rear roll center</p> |

CAMBER RISE

Also referred to as “camber intake,” this measurement quantifies how much the camber changes on the car when the suspension is compressed.

Rear camber rise on the NT1 is adjustable via the rear upper camber link, by changing its inner and outer mounting locations, as well as length.

To measure camber rise, set the car at normal ride height and then measure the camber on the camber gauges. Next, push on the suspension, and measure the camber again. The difference between those two camber angles represents the camber rise.

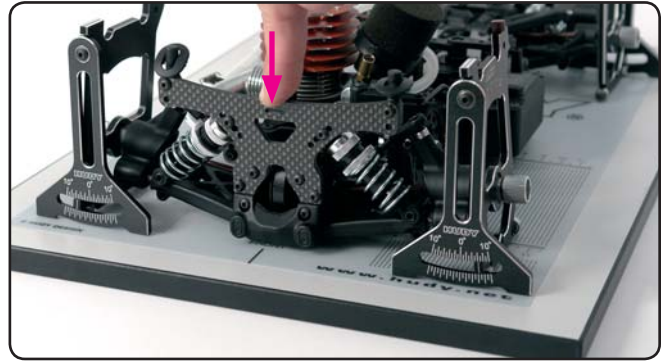





ADJUSTING CAMBER RISE

Adjust camber rise by changing the inner and outer mounting positions of the rear upper camber link.

- **MORE camber rise:** SHORTER camber link
- **LESS camber rise:** LONGER camber link

After you change the camber link mounting positions, you must alter the length of the link to obtain the proper camber setting.

| | Holes | Linkage length | Effect on rear camber rise |
|---|--|----------------|----------------------------|
| REAR ROLL CENTER TOWER (camber link inner mounting positions) | | | |
|  | Outer holes (upper or lower) | Shorter | More rear camber rise |
|  | Inner holes (upper or lower) | Longer | Less rear camber rise |
| REAR UPRIGHT (camber link outer mounting positions) | | | |
|  | Inner hole | Shorter | More rear camber rise |
|  | Outer hole | Longer | Less rear camber rise |

STEERING ACKERMANN

Ackermann controls the difference in steering arcs between the front inside and outside wheels. The inside wheel always has a tighter arc in any corner. The amount of grip provided by the tires, in relation to the steering arc and speed of the car, create an amount of measurement called a "slip angle" for each wheel. For some tires you need a greater difference in slip angles between the inner and outer wheel and for some you need less.

The size and geometry of the servo saver on XRAY cars forces the inside wheel to increase its turning angle at a greater rate than the outside wheel, as the servo turns either way from center. The rate of the increase, called Ackermann effect, can be changed by the angle of the steering rods connecting the servo saver to the steering blocks. The straighter the rods are in relation to each other, the more Ackermann effect will be applied to the inside wheel.

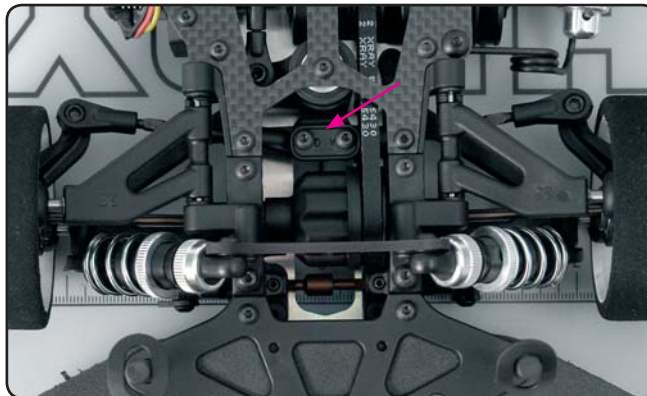

Slip angles work differently on each wheel when the car is slowing down & pitching forward, than when the throttle is applied & the tires are pulling the car forward. The goal in tuning Ackermann is to get the car to keep a consistent steering arc after going from off-power to on-power, while not allowing the front inside wheel to be turned too much and drag through the corners instead of rolling through them. If the car steers well off-power but pushes on-power, then use more Ackermann effect and decrease your transmitter EPA/dual rate. If the car steers well on-power and pushes off-power, or if you can hear the front inside wheel chattering at mid-corner, then use less Ackermann effect and increase your transmitter EPA/dual rate.

ADJUSTING ACKERMANN

The angle of the steering rods (and hence the Ackerman effect) can be adjusted by changing the location of the steering rods inner mounting positions on the servo saver. This is accomplished by using Ackermann inserts.

- **Least Ackermann effect:** Servo saver insert with holes furthest FORWARD; steering rods most angled.
- **Most Ackermann effect:** Servo saver insert with holes furthest REARWARD; steering rods straightest.

We recommend using more Ackermann in low-to-medium grip conditions, and less Ackermann in medium-to-high grip conditions.

| ACKERMANN EFFECT | Least | ← → | | Most |
|---------------------------------------|-------------|-----|--|-------------|
| <p>Steering Saver Insert Position</p> | | | | |
| Steering Rod Angle | Most angled | ← → | | Straightest |



FRONT & REAR AXLES

FRONT AND REAR AXLES

The XRAY NT1 comes standard with a single choice for rear axle, and 2 options for front axle. The choice of front axle depends on track conditions and driving style.

Front Axles:

- Front gear differential (standard)
- Solid front axle
- XRAY Multi-Diff™

Rear Axle:

- Rear gear differential (standard)

GEAR DIFFERENTIALS

Differentials allow the wheels at opposite ends of the same axle to rotate at different speeds. Why is this important? When a car turns in a circle, the outer wheel has a larger diameter circle to follow than the inner wheel, so it needs to rotate faster to keep up. If the differential is too tight, the result is that the wheels “fight” each other for the proper rotation speed; the result is a loss of traction. Generally, the more grip a track has, the tighter the diff action should be.

The gear differentials included as standard with the XRAY NT1 give smooth differential action and high durability. Also, due to their geared design, there is none of the gear slippage that is associated with ball differentials.

Gear differentials are easy to adjust in that there is only one tuning factor — the weight of the oil used. This makes it very easy to share setups with others using a gear differential.



EFFECTS OF GEAR DIFFERENTIAL ADJUSTMENT

FRONT GEAR DIFFERENTIAL

| | |
|---|---|
| Lighter diff action (thinner oil) | <ul style="list-style-type: none"> • Decreases understeer • Decreases stability under braking and acceleration • Increases chance of traction roll |
| Heavier diff action (thicker oil) | <ul style="list-style-type: none"> • Increases understeer • Increases stability under braking and acceleration • Decreases chance of traction roll |

REAR GEAR DIFFERENTIAL

| | |
|---|---|
| Lighter diff action (thinner oil) | <ul style="list-style-type: none"> • Decreases on-throttle steering • Less acceleration if the track has good traction • Less predictable car (cars with very “loose” diffs have a tendency to understeer heavily under throttle and turn-in oversteer as soon as you lift) • Less on-throttle oversteer (snap-oversteer) • Less turn-in understeer • Less stable under braking |
| Heavier diff action (thicker oil) | <ul style="list-style-type: none"> • Increases on-throttle steering • Better acceleration if the track has good traction • More predictable car (cars with very “loose” diffs have a tendency to understeer heavily under throttle and turn-in oversteer as soon as you lift) • More on-throttle oversteer (snap-oversteer) • More turn-in understeer • More stable under braking |

ADJUSTING THE GEAR DIFFERENTIALS

Gear differential action is adjusted by filling the gear differential with differential oil of a specific viscosity.

Differential oil is rated with a “viscosity” number that indicates the thickness of the oil, which determines how much the oil resists flowing. Differential oil with a higher viscosity (for example, 100 000 cSt oil) is thicker than differential oil with a lower viscosity (for example, 1000 cSt oil).

The NT1 features new XRAY Premium Silicone Oils manufactured in Europe by a specialized premium silicone oil manufacturer; these new oils were created exclusively for XRAY. Each batch of premium oil is laboratory tested and calibrated to ensure the highest possible consistency and quality from batch to batch. Based on the industry-proven CST rating, the new line of oils is very easy to identify, adjust, and feel.

- **LIGHTER differential action:** Fill differential with THINNER gear oil
- **HEAVIER differential action:** Fill differential with THICKER gear oil



| | | | | | |
|------------------|------------------|------------------|------------------|------------------|-------------------|
| 359330 | 359340 | 359350 | 359360 | 359380 | 359392 |
| 30.000cSt | 40.000cSt | 50.000cSt | 60.000cSt | 80.000cSt | 100.000cSt |

THIN → **THICK**

SOLID FRONT AXLE

A solid front axle ties both left and right front wheels together so they rotate at the same speed at all times. The car achieves maximum 4WD braking, while being very stable and easy to drive.



| | |
|----------------------------|---|
| Off-power: | Decreased off-power steering |
| On-power: | Increased on-power steering |
| Best combined with: | Rear differential |
| Typically used on: | Large open outdoor tracks, tracks with braking areas, or slippery (low-traction) conditions |
| Advantage: | 4-wheel braking allows for later braking |
| Considerations: | <ul style="list-style-type: none"> With less off-power steering, the car becomes more sensitive to tire diameter differences. To compensate for these effects, changes can be made to the suspension (for example, roll center, front spring rate and/or damping, shock position, or caster). Decreased drivetrain efficiency (less runtime). Best suited to an aggressive driving style. |

The front gear differential may be quickly and easily converted into a solid front axle by using the Solid Locking Adapter (#335040) included in the NT1 kit. The adapter replaces internal gears and locks the two outdrives together.

XRAY MULTI-DIFF™

The optional XRAY Multi-Diff™ may be used in the NT1, and be quickly and easily configured to be one of three different types of front axle: front solid axle, front solid one-way, and also a front one-way.



XRAY MULTI-DIFF™ — FRONT SOLID AXLE

With the optional XRAY Multi-Diff™ set to “full-time solid axle” mode, both outdrive shafts (left and right) are connected to front main axle by the internal locking axle and locking pin.

The characteristics using the Multi-Diff™ in “full-time solid axle” mode are exactly the same as locking the front gear differential.

For more details see “Solid Front Axle” table.

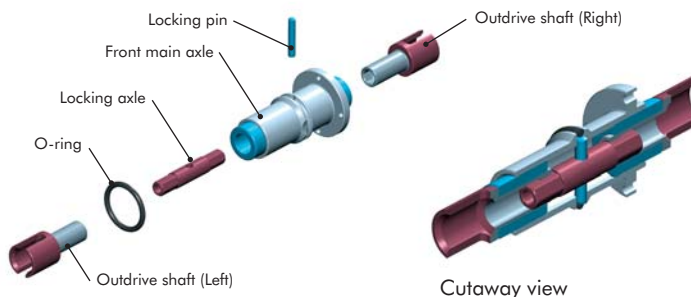

XRAY MULTI-DIFF™ — FRONT SOLID ONE-WAY AXLE

With the optional XRAY Multi-Diff™ set to “front solid one-way” mode, both outdrives (left and right) are connected together by internal locking axle, but are not connected to front main axle.

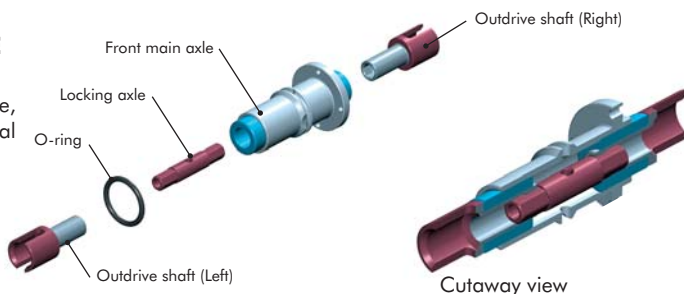

| | |
|----------------------------|---|
| Off-power: | Both front wheels rotate forward together (but independently of the front main axle). |
| On-power: | Both front wheels rotate forward together (locked in one-way bearings), at same speed as front main axle. |
| Best combined with: | Rear differential. |
| Typically used on: | Medium-to-high traction tracks where braking for corners is not required. |
| Advantage: | Good off-power steering and efficiency. |

XRAY MULTI-DIFF™ — FRONT ONE-WAY AXLE

With the optional XRAY Multi-Diff™ set to “front one-way” mode, both outride shafts (left and right) are not connected to each other, nor to the front main axle. This mode combines the characteristics of a solid axle and a differential.

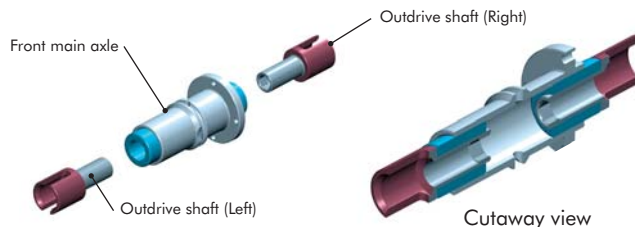

| | |
|--|--|
| Off-power & braking: (corner entry & mid-corner) | Front inner and outer wheels rotate forward independently of each other, making axle behave like a front differential. There is NO front braking. |
| On-power: (mid-corner and corner exit) | Both front wheels rotate with front main axle (locked in one-way bearings) at the same speed, making the front axle behave like a front solid axle. Introduces some on-power understeer. |
| Best combined with: | Rear differential or solid rear axle (if available). |
| Typically used on: | High-traction tracks. The car leans towards on-power understeer and the track does not require braking for the corners. Will give maximum off-power steering and increase efficiency (more runtime). Best suited to a smooth driving style. |
| Considerations: | <ul style="list-style-type: none"> The front one-way axle allows you to use slightly bigger rear tires than front tires, and to have the rear wheels overdrive the front wheels. In that situation, when the rear wheels lose traction the front wheels engage and start helping to generate forward traction. It is very important to know that when using a front one-way axle, you get no front wheel braking. While this gives you better steering response going into a corner, the effect may cause the rear of the car to break traction more easily. |

GEARING

Proper gearing is one of the most essential tuning options required to maximize the performance potential of your NT1. The key to proper gearing is finding and maintaining the best rollout and overdrive ratio for each track environment, engine/chassis setup and driving style.

Rollout is the distance the car will travel in one revolution of the engine (with clutch engaged). Pinion and spur gears are used to generate the desired rollout, considering the diameter of the tires mounted. Rollout determines top speed and acceleration.

Typically, a higher rollout will provide less acceleration and more top speed, and a lower rollout will be quicker off the line, but with less top speed. It is possible, however, to lose too much low-end torque needed to effectively accelerate the weight of the car out of a slow corner by undergearing to a smaller rollout, or having an engine at too high RPM with very little useable torque.

However, if the engine is overgeared at too high of a rollout, the excessive torque will put undue strain on the engine.

Overdrive is determined by the use of different mid-side pulleys, which affects the rotation speeds of the front and rear wheels, ultimately affecting the driving characteristics of the car. A neutral overdrive ratio (1:1) allows the front and rear wheels to rotate at the same speed, giving neutral driving characteristics. A car that is overdriven (example, overdrive ratio of 1.04:1) has the front wheels rotating faster than the rear wheels, giving the car the driving characteristics of a front wheel drive car that “pulls” its way out of corners.

In order to accelerate the process of dialing your NT1 at a track that you have never raced at, you should ask drivers who are familiar with the track about their rollout and overdrive. Using that information — with the calculations explained in this section — should help you to set the rollout and overdrive of your NT1 to a good starting point, regardless of the other differences between cars.

DRIVETRAIN RATIO (DTR) — INTERNAL RATIO

A “drivetrain ratio” (DTR) is the ratio of all the internal gears from the transmission, including differentials and pulleys.

The front and rear DTR values may differ depending on mid-side pulley used.

The rear DTR of the XRAY NT1 is permanently set to 2.05.

The front DTR value may be changed by using different mid-side pulleys:

- When using the 26T mid-side pulley, the front DTR is **2.05** (1:1 overdrive)
- When using the 25T mid-side pulley, the front DTR is **1.97** (1.04:1 overdrive)

The ratio between front and rear DTR values is the “overdrive ratio” described later.



PRIMARY DRIVE RATIO (PDR)

The “primary drive ratio” (PDR) is the ratio between the pinion and spur gear, and is one of the most straightforward way to change the overall drive ratio of the NT1.

- Larger spur / smaller pinion = high (“long/tall”) PDR ratio = faster acceleration but lower top speed
- Smaller spur / larger pinion = low (“short”) PDR ratio = slower acceleration but higher top speed

The 1st and 2nd PDR ratios of the NT1 may be altered by the use of different combinations of pinion and spur gears on the clutchbell and 2-speed transmission, respectively.

Spur / Pinion = PDR
 Sample 1st gear PDR:
 59T spur / 16T pinion = 3.688

XRAY offers the following gearing options for the pinion and spur gears on the NT1:



Pinion Gears

1st gear (smaller, outer pinion) : 15, 16, 17, 18T
2nd gear (larger, inner pinion) : 20, 21, 22, 23T



Spur Gears

1st gear (larger, outer spur) : 57, 58, 59, 60T
2nd gear (smaller, inner spur) : 53, 54, 55T

FINAL DRIVE RATIO (FDR)

The "final drive ratio" (FDR) is the ratio between the DTR and the PDR.

Since FDR is directly affected by DTR, a front FDR is affected by changes to the mid-side pulley (which alters the front DTR).

PDR x DTR = FDR

Sample 1st gear rear FDR (unaffected by pulley changes):
 3.688 x 2.05 = 7.56

Sample 1st gear front FDR (using 25T mid-side pulley):
 3.688 x 1.97 = 7.26

OVERDRIVE RATIO (ODR)

The "overdrive ratio" (ODR) is the ratio between the front DTR and the rear DTR, and is affected by the mid-side pulley used on the NT1. Overdrive ratio impacts the difference in rotation speed between the front and rear wheels.

Depending on the mid-side pulley being used, the FDR values will be different between the front and rear of the NT1:

- Rear DTR of the NT1 is permanently set to **2.05**.
- When using the **26T** mid-side pulley, both front and rear DTR ratios are **2.05**. This gives a 1:1 overdrive ratio. The front and rear wheels rotate at the same speed.
- When using the **25T** mid-side pulley, the front internal ratio (DTR) becomes **1.97**. When compared to the rear DTR of 2.05, the overdrive ratio now becomes 1.04:1. The front wheels rotate 4% faster than the rear wheels.

| DTR RATIO | MID-SIDE PULLEY | |
|-----------|-----------------|-------------|
| | 26 | 25 |
| Front DTR | 2.05 | 1.97 |
| Rear DTR | 2.05 | 2.05 |

| OVERDRIVE RATIO | 1 : 1 | 1.04 : 1 |
|-----------------|--------------|-----------------|
|-----------------|--------------|-----------------|

ROLLOUT

Rollout is the distance that the car moves forward for one revolution of the engine (or pinion gear). Rollout is not affected by the engine or other components you are using; it simply defines how all of the gears, belts/shafts and tires work together to make the car accelerate and reach top speed. Rollout is calculated using the circumference of a tire. Since the NT1 uses foam tires, as the foam tires wear and get smaller, the rollout value changes a lot more quickly.

Rollout calculations may be done for both front and rear wheels, since the FDR ratios for front and rear may be different. The example below is a calculation of rollout for the rear tires on the NT1 in 1st gear.

Rear Tire Circumference = Rear Tire Diameter x 3.14 (value of Pi)
 Rear Rollout = Rear Tire Circumference / Rear FDR (1st gear)
 Sample rear tire circumference: 59 mm x 3.14 = 185.35mm
 Sample 1st gear rear rollout: 185.35mm / 7.56 = 24.52mm

For each engine revolution in 1st gear, the rear tires move the car forward by 24.52mm

OVERDRIVE RATIO, ROLLOUT, AND TIRE SIZE

Overdrive ratio and rollout are affected by the diameters of the front and rear tires used.

When using the 26T mid-side pulley:

If you use the 26T mid-size pulley, the ODR ratio is 1:1 (based on gearing ratios alone).

When you start racing the car with rear tires that have a larger diameter than the front (for example, a 2.0–2.5mm difference), the rear wheels will push the front wheels and the front wheels brake the car.

However, since rear tire wear is usually higher than front tire wear, after some running time the front and rear tire diameters will equalize and then the push will equalize as well.

When using the 25T mid-side pulley:

If you use the 25T mid-size pulley, the ODR ratio is 1.04:1 (based on gearing ratios alone); the front wheels rotate 4% faster than the rear wheels.

When you start racing the car with rear tires that have a larger diameter than the front (for example, a 2.0–2.5mm difference), this tire size difference will neutralize the ODR and the car will be balanced with no push between the front & rear wheels.

However, since rear tire wear is usually higher than front tire wear, after some running time the front and rear tire diameters will equalize; the front wheels will start to pull, and the rear wheels will brake the car.

Please note that this situation varies depending on the type of track and the differences in wear characteristics of the front versus rear tires. It is important to always individually consider the best and optimal combination of gearing, and diameters of the front and rear tires.

SHOCK BUILDING TIPS

COMPOSITE PARTS PREPARATION

Carefully use a hobby knife (at a perpendicular angle) or fine file to gently remove excess composite material from the outer edge of each piston. This is a critical step; the outer edges of the shock pistons must be smooth and round.



LOWER SHOCK BALL JOINT INSTALLATION

1. Install the metal pivot ball into the shock lower ball joint.
2. Pre-thread the ball joint using an M3x8 screw.
3. Hold the shock rod with a shockrod clamping tool, or use a pair of side cutters to grip the top groove of the threaded end section. Tighten the ball joint onto the shock rod. If using side cutters, make sure the flat side of the wire cutter blades are facing the ball joint. If necessary, use a pair of gripping pliers (e.g. Vise Grips™) to hold the handles of the side cutters to prevent the shock rod from turning.
4. While gripping the shock rod, screw the ball joint on a few turns with your fingers. Then use pliers to clamp the pivot ball inside the ball joint and tighten the ball joint all the way onto the threads.

PERIODIC SHOCK MAINTENANCE

The most important maintenance task for keeping consistent shock performance is refilling and bleeding them correctly. If built correctly, it will not be necessary to re-build them often. Replacing warped/hard rubber bladders and o-rings, scarred piston rods, or shaved/split/loose composite upper and lower ball joints are also important.

- For club racing, it is recommended to check the shocks for air inside before each race and only re-fill and bleed them if necessary. Before each race day, make sure you take the spring off of each shock, hold it up to your ear, and quickly compress the shock rod fully into the body while listening for any air making a “whistling” or “squishy” sound as it passes through the piston holes. If you hear any air, refill and bleed your shocks. For high competition racing, it is recommended that the shocks be re-filled and bled before a large event.
- If building or pairing new shocks, always make sure they are the same length using a shock length measuring tool and adjust the lower ball joints as needed.
- If installing new rubber bladders, carefully trim the thin excess rubber from the edges of their lips. Curved body scissors work the best.

FILL AND BLEEDING PROCESS

1. Unscrew the top aluminum shock cap nut and remove the entire top assembly.
2. Drain the oil from the shock body.
3. Unscrew the end cap from the bottom of the shock body.
4. Clean all of the shock parts thoroughly with electric motor cleaner. Make sure to only use a cleaner that DOES NOT leave a residue.
 - For adjustable pistons, open all four piston holes .
 - Fill the shock body with cleaner and pump the cleaner through the piston holes three or four times by pushing/pulling the shock rod.
 - Dry all of the parts thoroughly.
5. Completely cover both small and large O-rings under the end cap with shock oil and screw on the end cap.
6. Make sure all four holes are open and the piston/rod is at the bottom of the shock body.
7. Hold the shock upright and slightly overfill the shock body with shock oil.
8. Air bubble removal:
 - Pump the piston once, without letting it come close to the surface of the oil.
 - If using adjustable pistons, close and reopen all holes to eject small air bubbles caught between the piston halves.
 - Rotate the piston by 1 position.
 - Repeat this process 4 or more times.
 - Add shock oil as necessary.
 - Pull the piston rod most of the way out of the shock body. Let the shock rest for 5 minutes to allow the air bubbles to escape.
9. Membrane and top cap installation:
 - Insert the composite upper ball joint into the alu shock cup.
 - Insert the shock foam insert into the composite upper ball joint.
 - Insert the shock absorber membrane into the alu shock cup.
 - After you insert the membrane ensure that it sits properly all around the alu cup properly.
 - When installing the shock cap assembly on the shock body, some oil will leak out... this is normal.
 - Fully tighten the cap and clean off any excess oil.
 - After the shock is assembled, the shock rod will push itself out of the shock body fairly quickly.

NOTE: If the cap nut is not tightened enough, it may unscrew itself when you try to adjust the ride height using the threaded spring collars.
10. Adjusting rebound:
 - To set the Shock Rebound, release the shock composite lower cap.
 - VERY SLOWLY do the following: Fully pull out the shock rod, push it back in fully, and then fully pull it out once more. Repeat this procedure the following number of times to achieve the desired Shock Rebound setting:
 - 10 times - approximately 75% rebound (high rebound - suggested for very low traction track)
 - 15 times - approximately 50% rebound (medium rebound - suggested for standard track)
 - 20 times - approximately 25% rebound (low rebound - suggested for very high traction track)
 - During the Rebound Adjustment procedure shock oil will leak out of the shock body through the O-ring on the shock rod... this is normal. During the Rebound Adjustment procedure DO NOT open the upper shock cap.
 - After you have set the Rebound Adjustment, re-install the shock lower composite cap.

11. Checking rebound:

Check the Shock Rebound setting by pushing the shock rod fully into the shock body, releasing it, and observing how far the shock rod extends by itself:

- * 25% out of the shock body (low rebound)
- * 50% out of the shock body (medium rebound)
- * 75% out of the shock body (high rebound).

If the shock rod rebounds too much, return to Step 1 and repeat the procedure. If the shock rod does not rebound enough, you will have to refill the shock with shock oil, and then repeat the bleeding and Shock Rebound adjusting procedure.

12. Use motor cleaner to clean any excess oil from the outside of the shock.

13. Place a small amount of light oil onto the threads above the aluminum ride height collar and let it soak in. This will keep the collars from binding on the shock body threads when adjusting ride height.

NOTE: It is normal for some oil to bleed out of the bottom of freshly-filled shocks during the first few runs of the car. However, they will equalize at the right pressure without letting any air in if the O-rings are still in good condition.

FOAM TIRE TIPS

GENERAL

- Make sure you rotate the front and rear pair from side-to-side after one or at the most two runs on the track. This will allow them to wear evenly throughout their life as most tracks cause one side to wear more than the other. Uneven wear is common since most tracks have either a high-speed sweeper or more turns in one direction.
- Use a micrometer to measure the diameter of your tires before and after each run. Taking measurements will help you to make sure that any handling problems are not caused by unequal tire diameters. Taking measurements of the inside and outside edges of each tire after a run will also help you to diagnose setup problems, such as improper or unequal camber or camber rise settings.
- Mark each tire with its original position (LF, RF, LR & RR) on the car with a permanent marker. Include its compound if there is more than one compound being used at any given time and they are not already marked. This will help you to keep track of what is happening with each tire concerning the tips below and also minimize mounting the wrong compound on the front or rear.

PREVENTING CHUNKING

- Aside from hitting things, your tires will chunk more often if there is not enough negative camber in the middle of the turns at full chassis roll to keep them from riding on their outer edges. This happens more often on the rear tires than on the front.
- Place a semi-thick coat of CA glue on the entire outer sidewall of the tire, from the edge of the rim to the top of the sidewall and let it dry sufficiently (20-30 minutes). You can speed up the drying process by wrapping the outer/bottom surface of the tire with a paper towel, and spraying instant cure onto the wet CA glue. Wrapping the surface keeps the instant cure spray off the tires contact patch and possibly minimizing grip. Mount the tire on a tire truer and use a file or sandpaper to round off the inner and outer edges of each tire and remove approximately 1mm of the CA glue from the top edge of the outer sidewall. This will allow the outer sidewall of the tire to flex some while cornering and keep the CA from cracking. You will need to round off the edges every two to three runs as well.

TIRE CONING & CAMBER RISE

- Check the diameters of the inner and outer edges of each tire after each run. Pay particular attention to the side of the car that wears the tires down the fastest as this side will shoulder the greatest amount of cornering forces for any given track. Treat both front and rear tire pairs separately, even if they are the same compound. If either tires outer edges within a front or rear pair have a smaller diameter than their inner edges, then increase the static camber in 0.5° increments, rotate the tires from left to right and track test them again. Keep increasing the static camber until the tires wear evenly flat on the front, and one or both of the rear tires wear just a little bit more on their inside edges (no more than 0.1mm after two or more runs). If you follow these steps and reach -3.0° camber on a set and one or both of them are still wearing the outside edge, then you need to increase the amount of camber rise on the rear outside wheel as the suspension compresses during cornering. This is accomplished by altering the rear camber rise. For more information, see section Camber Rise.

BEARING MAINTENANCE

DRIVETRAIN BALL-BEARINGS

The following procedures are recommended to clean all of the drivetrain ball-bearings in your NT1. For high-competition racing, we recommended doing this every 3-4 weeks, or before a major event.

1. Remove the blue seals on both sides of the bearing by inserting the tip of a hobby knife into the inner seam and prying the seal up and out.
2. If the seal bends a little and you can see a kink, carefully flatten the kink out by hand.
3. Spray the seals with motor cleaner and blow dry with compressed air.
4. Spray the bearing on both sides with motor cleaner.
5. Spin the bearing while it is still wet to dislodge any particles with the cleaner.
6. Spray the bearing on both sides again.
7. Blow both sides of the bearing dry with compressed air to make sure particles come out.
8. Hold the inner part of the bearing with my left thumb/forefinger and spin it to make sure it spins free without any abnormal vibrations or sounds.
9. Place one drop of bearing oil into each side of the bearing.
10. Replace both seals at the same time by lining them up on each side of the bearing and lightly pressing them in all the way around the bearings circumference with your thumb and forefinger. Do not press too hard or use any type of tool, such as a wrench tip, to push the blue seals in as they will push in too far, bend and cause drag.

If you spin test the bearing after you have re-oiled and sealed it, it will not spin freely for an extended period of time. The lightest of oils may allow it to spin for 1-2 seconds. This is normal and once you have mounted the bearings in the car again, the drive train will spin freely.

Make sure you use a motor cleaner that does not leave a residue after it dries as this may cause drag and wear in the bearings.

XCA CLUTCH BEARINGS

The thrustbearing in the XCA clutch should be re-greased at least once every 30 minutes, or more often if you run on dirty tracks or your car goes off the track often. We recommend using a thick, high-tack grease such as graphite grease.

The ball-bearings in the XCA clutch should be oiled regularly with a good, light bearing oil. The ball-bearings are subjected to high heat for extended periods, and have a tendency to get "rusty" after a short time (which may lead to failure if not oiled).

www.teamxray.com

XRAY EUROPE

XRAY, K VÝSTAVISKU 6992, 91101 TRENCIN, SLOVAKIA, EUROPE
PHONE: +421-32-740 11 00, FAX: +421-32-740 11 09, info@teamxray.com

XRAY USA

RC AMERICA, 167 TURTLE CREEK BLVD, SUITE C, DALLAS, 752 07 TEXAS, USA
PHONE: 214-744-2400, FAX: 214-744-2401, xray@rcamerica.com



ALL RIGHTS RESERVED. © XRAY. ALL ARTWORK & DESIGN BY XRAY.

